



# Zoom Box Camera Series Hardware Manual

E213, E215, E223

2015/05/14



# Table of Contents

## **Precautions ..... 4**

---

Safety Instructions .....	6
---------------------------	---

## **Introduction..... 7**

---

The List of Models .....	7
Package Contents.....	8
Physical Description .....	9
Mounting Options .....	11

## **Before Installation..... 13**

---

<b>How to Connect DI/DO and Audio Devices (Optional).....</b>	<b>13</b>
How to Connect DI/DO Devices .....	13
How to Connect Audio Devices .....	17
<b>How to Connect a Serial Device .....</b>	<b>18</b>

## **Indoor Installation Procedures ..... 20**

---

<b>Step 1: Attach the Mounting Block.....</b>	<b>20</b>
<b>Step 2: Mount the Indoor Bracket .....</b>	<b>21</b>
<b>Step 3: Attach the Camera to the Bracket .....</b>	<b>21</b>
<b>Step 4: Connect the Cable(s).....</b>	<b>23</b>
<b>Step 5: Access the Camera Live View.....</b>	<b>24</b>

## **Other Adjustments and Accessories ..... 25**

---

<b>How to Install / Remove the Memory Card .....</b>	<b>25</b>
How to Insert the Memory Card .....	25

How to Remove the Memory Card..... 25

**Accessing the Camera ..... 26**

---

**Configure the IP Addresses ..... 26**

**Access the Camera..... 30**

# Precautions

## **Read these instructions**

You should read all the safety and operating instructions before using this product.

## **Heed all warnings**

You must adhere to all the warnings on the product and in the instruction manual. Failure to follow the safety instruction given may directly endanger people, cause damage to the system or to other equipment.

## **Servicing**

Do not attempt to service this product yourself as opening or removing covers may expose you to dangerous voltage or other hazards. Refer all servicing to qualified service personnel.

## **Trademarks**

ACTi and ACTi logo are registered trademarks of ACTi Corporation. All other names and products used in this manual are registered trademarks of their respective companies.

## **Liability**

Every reasonable care has been taken during the writing of this manual. Please inform your local office if you find any inaccuracies or omissions. ACTi will not be held responsible for any typographical or technical errors and reserves the right to make changes to the product and manuals without prior notice.

**Federal Communications Commission Statement**

This equipment has been tested and found to comply with the limits for a class B digital device, pursuant to Part 15 of the FCC Rules. These limits are designed to provide reasonable protection against harmful interference in a residential installation. This equipment generates, uses, and can radiate radio frequency energy and, if not installed and used in accordance with the instructions, may cause harmful interference to radio communications. However, there is no guarantee that interference will not occur in a particular installation. If this equipment does cause harmful interference to radio or television reception, which can be determined by turning the equipment off and on, the user is encouraged to try to correct the interference by one or more of the following measures:

- Reorient or relocate the receiving antenna.
- Increase the separation between the equipment and receiver.
- Connect the equipment into an outlet on a circuit different from that to which the receiver is connected.
- Consult the dealer or an experienced radio/TV technician for help.

**Warning:** Changes or modifications to the equipment that are not expressly approved by the responsible party for compliance could void the user's authority to operate the equipment.

**European Community Compliance Statement**

This product has been tested and found to comply with the limits for Class B Information Technology Equipment according to European Standard EN 55022 and EN 55024. In a domestic environment, this product may cause radio interference in which cause the user may be required to take adequate measures.

## Safety Instructions

---

### **Cleaning**

Disconnect this product from the power supply before cleaning.

### **Accessories and Repair Parts**

Use only the accessories and repair parts recommended by the manufacturer.

### **Location**

Install this device in a dry place protected from weather.

### **Servicing**

Do not attempt to service this product yourself. Refer all servicing to qualified service personnel.

### **Damage Requiring service**

Disconnect this product from the power supply immediately and refer servicing to qualified service personnel under the following conditions.

- 1) When the power-supply cord or plug is damaged
- 2) If liquid has been spilled, or objects have fallen into the product.
- 3) If the inner parts of product have been directly exposed to rain or water.
- 4) If the product does not operate normally by following the operating Instructions in this manual.

Adjust only those controls that are covered by the instruction manual, as an improper adjustment of other controls may result in damage, and will often require extensive work by a qualified technician to restore the product to its normal operation.

### **Safety Check**



Upon completion of any service or repairs to this product, ask the service technician to perform safety checks to determine if the product is in proper operating condition.

# Introduction

## The List of Models





---

This hardware manual contains the following models:

E213		5MP Zoom Box with D/N, Basic WDR, 10x Zoom lens
E215		3MP Zoom Box with D/N, Superior WDR, 10x Zoom lens
E223		1.3MP Zoom Box with D/N, Superior WDR, 10x Zoom lens

From the installation perspective, these models are very similar; therefore one manual is used for all of them.

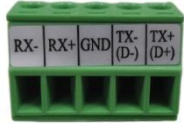
## Package Contents

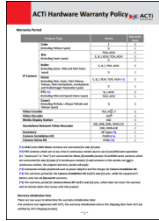
Camera	Audio and DI/DO Terminal Block	Serial Port Terminal Block (for E23B only)
		
Mounting Block with Screws	Quick Installation Guide	Warranty Card
		

**NOTE:** The pictures are for reference only, actual items may slightly vary in appearance.



## Physical Description

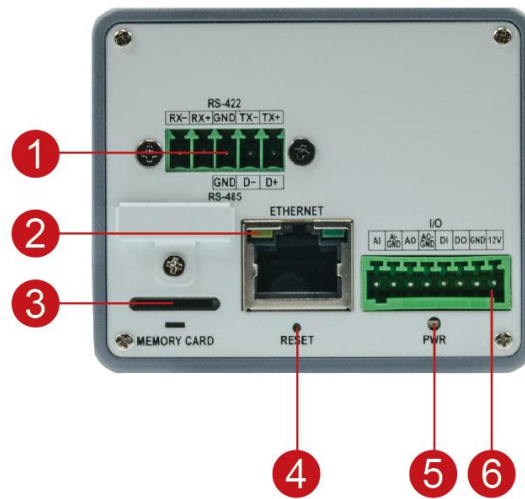







































Item	Description
1	<p>Serial Port</p> <p>This port connects to serial devices via RS-485 or RS-422 protocols. Use the supplied serial port terminal block to connect the wires from the serial device to the camera.</p> <p>See <a href="#">How to Connect a Serial Device</a> on page 18 for connection details.</p>
2	<p>Ethernet Port</p> <p>Connects to a network using an Ethernet cable.</p>
3	<p>Memory Card Slot</p> <p>Insert a memory card into this slot for local recording purposes. See <a href="#">How to Install / Remove the Memory Card</a> on page 25 for more information.</p> <p><b>NOTE:</b> Supports microSDHC and microSDXC cards.</p>
4	<p>Reset Button</p> <p>Restores the factory default settings of the camera. Resetting the camera must be done while the power is on. Using a pointed object, such as a paper clip, press and hold the <b>Reset Button</b> for at least 5 seconds or until the Power LED goes off .</p>
5	<p>Power LED</p> <p>The Power LED turns on when the camera is powered on and the system is running.</p>
6	<p>Digital Input / Output (DI/DO) and Audio Input / Output</p> <p>This connector connects to digital input or output devices, such as an alarm trigger, panic button, etc., as well as audio input and output devices, such as microphones and speakers. Digital Input</p>

Item	Description
	<p>(DI) and Digital Output (DO) devices are used in applications like motion detection, event triggering, alarm notifications, etc. See <a href="#">How to Connect DI/DO and Audio Devices (Optional)</a> on page 13 for more information.</p>

## Mounting Options

The camera can be installed both indoors and outdoors. For outdoor installation, additional waterproof housing is required. Below are several mounting options that you can use to install the camera. Select the most suitable solution for your installation environment.

Mount Types	Accessories
<b>Ceiling or Wall</b> (Indoor)	The camera comes with a mounting block which is used to mount an additional bracket to complete the installation. The additional bracket is not included in the camera package. You may use the bracket from a local supplier or purchase ACTi's indoor bracket. See <a href="#">Indoor Installation Procedures</a> on page 20 for more information.
	PMAX-1104 
<b>Wall</b> (Outdoor)	A waterproof housing is required when installing the camera outdoors. The following accessories can be used:
	PMAX-0200 (AC 110V) with heater and fan
	  
	PMAX-0201 (AC 220V) with heater and fan
  	
PMAX-0202 (no heater and no fan)	
  	

Mount Types	Accessories									
<b>Pole Mount</b> (SMAX-0093)	Suitable when mounting the camera on vertical poles. The camera must be enclosed inside the waterproof housing.									
	<table border="0"> <tr> <td>Housing</td> <td></td> <td>PMAX-1101</td> <td></td> <td>PMAX-0503</td> </tr> <tr> <td></td> <td></td> <td></td> <td></td> <td></td> </tr> </table> <p><b>NOTE:</b> The outdoor housing can either be PMAX-0200, PMAX-0201, PMAX-0200.</p>	Housing		PMAX-1101		PMAX-0503				
Housing		PMAX-1101		PMAX-0503						
										
<b>Corner Mount</b> (SMAX-0006)	Suitable when mounting the camera on a corner wall. The camera must be enclosed inside the waterproof housing.									
	<table border="0"> <tr> <td>Housing</td> <td></td> <td>PMAX-1101</td> <td></td> <td>PMAX-0402</td> </tr> <tr> <td></td> <td></td> <td></td> <td></td> <td></td> </tr> </table> <p><b>NOTE:</b> The outdoor housing can either be PMAX-0200, PMAX-0201, PMAX-0200.</p>	Housing		PMAX-1101		PMAX-0402				
Housing		PMAX-1101		PMAX-0402						
										

**NOTE:**

- For more information about the mounting solutions and accessories, please check the *Mounting Accessory Selector* in our website (<http://www.acti.com/mountingselector>).
- The above mounting accessories are not included in the package. Contact your sales agents to purchase.

# Before Installation

This section describes the procedures in preparing the Digital Input and Output (DI/DO) and Audio Input and Output devices that you can connect to the camera using the bundled terminal blocks. The use of these devices, however, is optional.

## How to Connect DI/DO and Audio Devices (Optional)

Depending on your surveillance needs, you may connect digital input / output or audio input / output devices to your camera. The camera comes with one (1) terminal block for both digital and audio input/output devices.

### How to Connect DI/DO Devices

Digital Input (DI) devices can be used to notify the camera about an activity in the camera site. DI can be triggers of events. For example, you can connect a “panic button” to the camera; as such when the panic button is pressed, the alarm signal will be sent through the camera. Other common DI device applications are emergency button, smoke detector, passive infrared sensor, etc.

Digital Output (DO) devices are external devices that are activated by the camera upon an event inside the camera. For example, you can connect an “alarm horn” to the camera; as such when an event occurs inside the camera (e.g. detected intruder), the alarm horn will sound. Other common DO device applications are motion-triggered lights, electric fence, magnetic door locks, etc.

Press and hold the orange tab as you insert the wire through the pin slot, then release the orange tab to secure the wire.

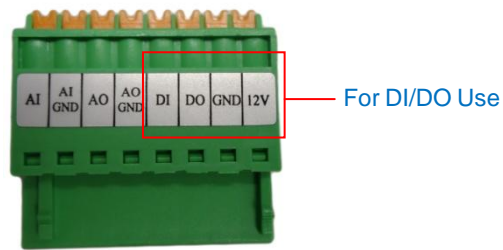

To connect digital input / output devices (DI/DO), map the pins to one of the pin combinations below:

Device	Pin	Mapping Instructions
Digital Output (DO)	12V	Connect the wires of the output device to <b>12V</b> and <b>DO</b> .
	DO	
Digital Input (DI)	GND	Connect the wires of the input device to <b>GND</b> and <b>DI</b> .
	DI	

The table below shows the DI/DO connection specifications:

Device			
DI	Connection design		TTL - compatible logic levels
	Voltage	To trigger (low)	Logic level 0: 0V ~ 0.4V
		Normal (high)	Logic level 1: 3.1V ~ 30V
	Current		10mA ~ 100mA
DO	Connection design		Transistor (Open Collector)
	Voltage & Current		< 24V DC, < 50mA

## Typical Connection

Based on these specifications, if the DI device has a voltage of 0V ~ 30V or the DO device has a voltage of < 24V (< 50mA), then the camera can supply internal power to these devices and there is no need to connect the DI/DO device to an external power source.

Use the **DIO GND** and **DI** pins to connect a DI device and use the **DIO PW** and **DO** pins to connect a DO device. See wiring scheme below:

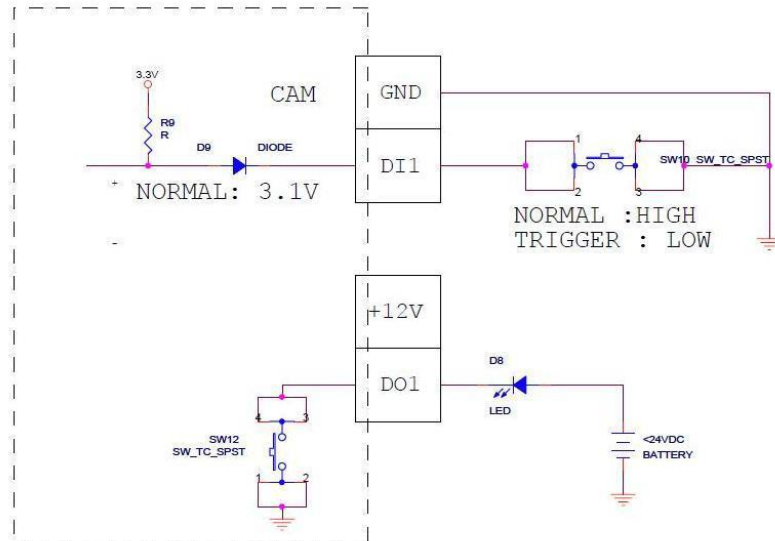

## High Voltage DO Device Connection

Even though the camera provides 12V power, this may not be enough for some high voltage DO devices, such as a ceiling light or a motor that opens or closes a gate. In this case, there is a need to connect an external relay. See wiring scheme below:

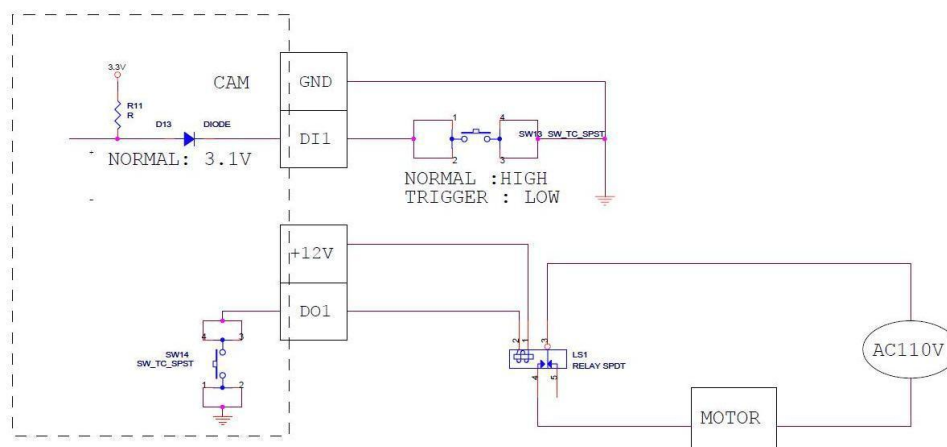

Note that when choosing an appropriate relay, please refer to its specifications and make sure they match the above design. The triggering circuit voltage has to be around 12V DC and the switch-controlled circuit voltage has to match the external power supply (e.g. 110V AC or 220V AC).

The illustration below is a graphic example of connecting a relay to a high voltage DO device.

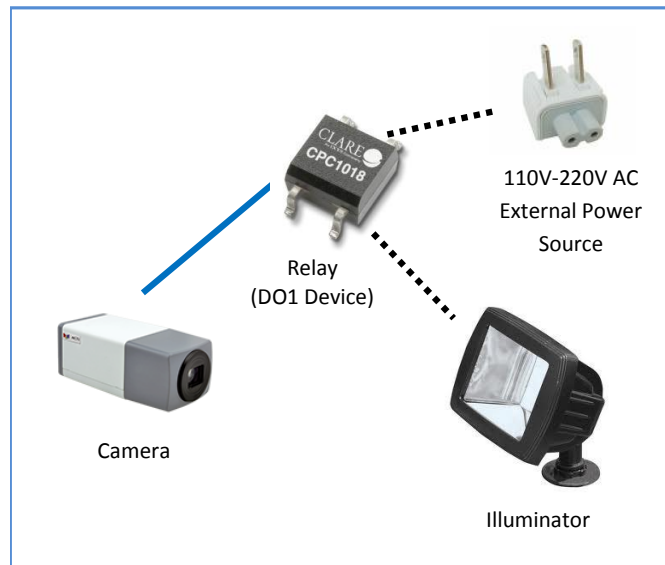

**NOTE:** For more information on DI/DO connections, please refer to the Knowledge Base article [All about Digital Input and Digital Output](http://www.acti.com/kb/detail.asp?KB_ID=KB20091230001) downloadable from the link below ([http://www.acti.com/kb/detail.asp?KB\\_ID=KB20091230001](http://www.acti.com/kb/detail.asp?KB_ID=KB20091230001)).



## How to Connect Audio Devices

Audio input / output devices, such as an active microphone or speaker can be connected to the camera using the supplied terminal block.

Press and hold the orange tab as you insert the wire through the pin slot, then release the orange tab to secure the wire.

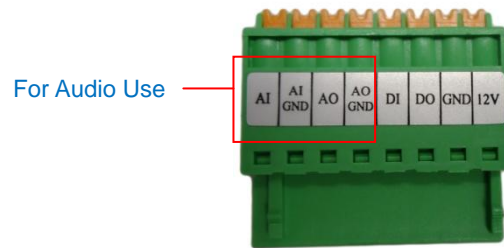

To connect audio devices, map the pins to one of the pin combinations below:

Device	Pin	Mapping Instructions
Audio Output (AO)	AO GND	Connect the wires of the audio output device to <b>AO GND</b> and <b>AO</b> .
	AO	
Audio Input (A1)	AI GND	Connect the wires of the audio input device to <b>AI GND</b> and <b>AI</b> .
	AI	

**NOTE:** For more information about AUDIO in connections, please refer to the Knowledge Base article [How to Use Audio-in of ACTi Cameras](http://www.acti.com/support/KnowledgeBase/outside/detail.asp?KB_ID=KB20100114003), downloadable from the link below ([http://www.acti.com/support/KnowledgeBase/outside/detail.asp?KB\\_ID=KB20100114003](http://www.acti.com/support/KnowledgeBase/outside/detail.asp?KB_ID=KB20100114003)).

## How to Connect a Serial Device

The camera can be connected to a **Pan-Tilt (PT) Scanner** (Pan-Tilt Head) using the serial port connector. This allows the zoom camera to do pan and tilt using the Pelco-D protocol. Most PT scanners accept Pelco-D and Pelco-P protocol commands via RS-485 or RS-422 connection, which are both supported by your camera.

Check the connection available on the PT scanner and connect it to your camera following the procedures below.

1. Map the wires from the PT scanner to your camera using the supplied terminal block according to one of the tables below.

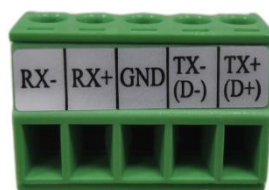

### Via RS-485 Connection

Terminal Block Label	Wire Mapping	
	Camera Pin	PT Scanner Pin
RX-	-	
RX+	-	
GND	GROUND PIN	
TX- (D-)	TX- (D-)	DATA-
TX+ (D+)	TX+ (D+)	DATA+

### Via RS-422 Connection

Terminal Block Label	Wire Mapping	
	Camera Pin	PT Scanner Pin
RX-	RX -	TX -
RX+	RX +	TX +
GND	GROUND PIN	
TX- (D-)	TX -	RX -
TX+ (D+)	TX +	RX +

**NOTE:** The pins of the PT Scanner may be labeled differently depending on the location or country where the scanner is purchased. For example, some PT devices may have RS-485 **DATA+** pins labeled as “TX+”, “RX+”, “A” or “485+”, etc. Refer to the scanner documentation or contact the manufacturer to verify the corresponding pin labels and ensure proper wiring connection.



**CAUTION:** Incorrect wiring may cause damage to the connected devices.

**DISCLAIMER:** ACTi will not be responsible for any damage caused by improper wiring.

2. Connect a ground wire to one of the **GND** terminal pin to complete the connection.

# Indoor Installation Procedures

This section describes the procedures in installing the camera indoors using PMA-1104 indoor bracket (purchased separately).

When using brackets from other manufacturers, check the installation guide included in the bracket to install the camera. Similar procedures apply when using brackets from other camera manufacturers.

**NOTE:** The pictures in this documentation are for reference only. Actual camera may slightly vary.

## Step 1: Attach the Mounting Block

Determine where you want to install the camera: **on the ceiling** or **on the wall**.

- **If the camera will be installed on the ceiling**, attach the mounting block on the top side of the camera.

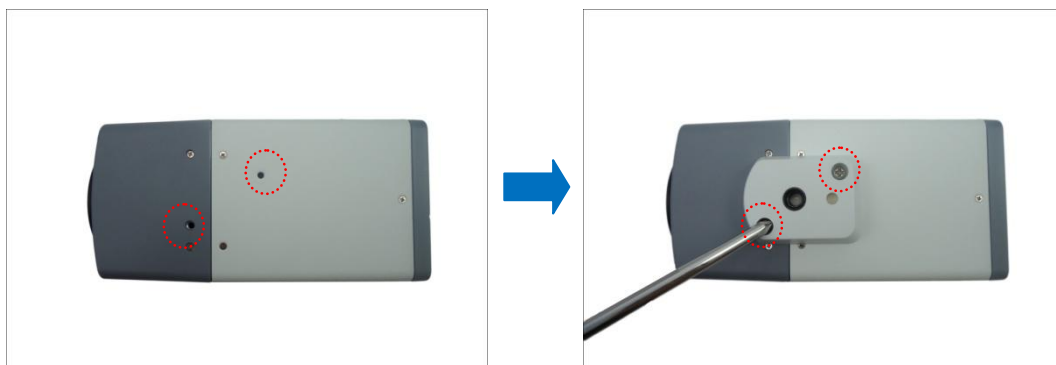

- **If the camera will be installed on the wall**, attach the mounting block on the bottom side of the camera. Secure the mounting block to the camera using the two (2) screws included in the mounting block package.

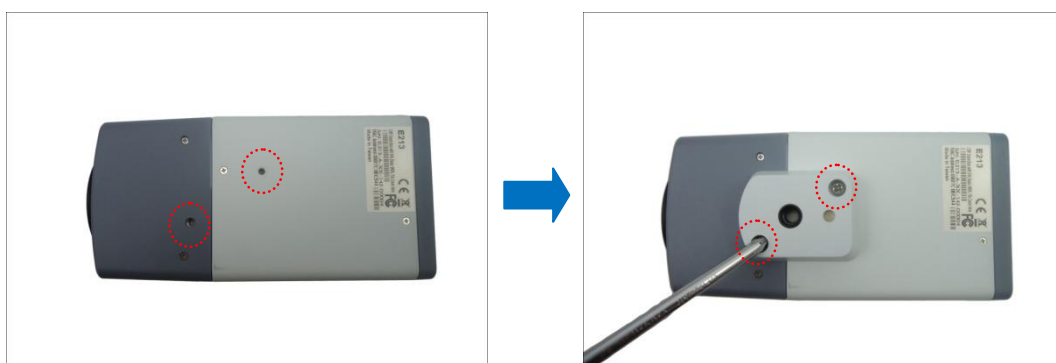

## Step 2: Mount the Indoor Bracket

**NOTE:**

- The indoor bracket is not included in the camera package and must be purchased separately.
- The pictures on the succeeding pages are for reference only, camera labels and appearance may vary depending on camera model.

Before installing the bracket, make sure the ceiling or wall can bear more than the weight of the camera and its accessories.

Install the indoor bracket to the ceiling or wall using the three (3) screws included in the bracket package.



## Step 3: Attach the Camera to the Bracket

**NOTE:** The following images show the mounting bracket attached on the bottom side of the camera. Same procedures apply when attaching the mounting bracket on the top side.

1. If necessary, insert a memory card into the memory card slot of the camera with the metal contacts facing down. Push until the card clicks into place. See [How to Install / Remove the Memory Card](#) on page 25 for more information.



2. Slightly loosen the knurled knob.



3. Screw the camera to the bracket by its mounting block.

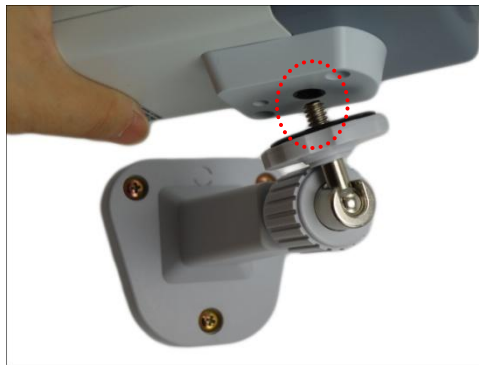

4. Tighten the hand knob until the camera is secured to the bracket.



5. Adjust the camera angle.



6. Tighten the knurled knob to fix the camera position.



## Step 4: Connect the Cable(s)

1. Connect the network cable to the Ethernet port of the camera.



2. If necessary, connect audio input/output or DI/DO devices to the camera. See [How to Connect DI/DO and Audio Devices \(Optional\)](#) on page 13 for more information.



3. Connect the other end of the network cable to a switch or injector. Then, connect the switch or injector to a network, PC and a power source. See Power-over-Ethernet (PoE) connection example below.

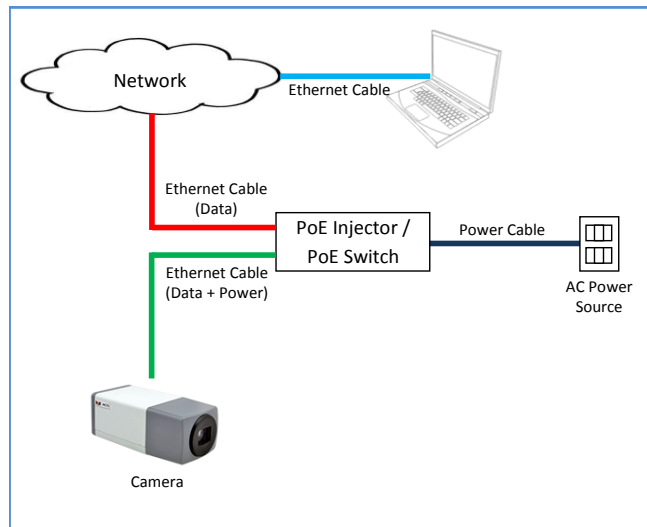

## Step 5: Access the Camera Live View

See [Accessing the Camera](#) on page 26 for more information on how to access the Live View of the camera.



# Other Adjustments and Accessories

## How to Install / Remove the Memory Card

The camera supports local video recording or saving of snapshots to a memory card.

**NOTE:** Supports microSDHC and microSDXC cards.

### How to Insert the Memory Card

1. Insert a memory card into the card slot with the metallic contacts facing down the camera. Push the card until it clicks into place.



2. To avoid unauthorized removal of the card, cover the memory card slot. To do this, loosen the screw and turn the tab to cover the memory card slot. Once the tab is in place, tighten the screw.

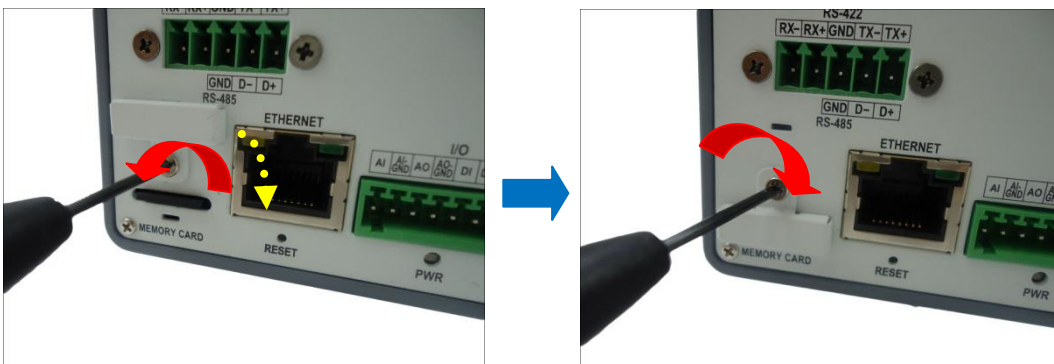

### How to Remove the Memory Card

In case there is a need to remove the card, make sure to access the camera Web Configurator to safely “unmount” the card first (see the camera Firmware manual for more information). Once unmounted from the firmware, push the card to eject it from the slot.

# Accessing the Camera

## Configure the IP Addresses

In order to be able to communicate with the camera from your PC, both the camera and the PC have to be within the same network segment. In most cases, it means that they both should have very similar IP addresses, where only the last number of the IP address is different from each other. There are 2 different approaches to IP Address management in Local Area Networks – by DHCP Server or Manually.

### Using DHCP server to assign IP addresses:

If you have connected the computer and the camera into the network that has a DHCP server running, then you do not need to configure the IP addresses at all – both the camera and the PC would request a unique IP address from DHCP server automatically. In such case, the camera will immediately be ready for the access from the PC. The user, however, might not know the IP address of the camera yet. It is necessary to know the IP address of the camera in order to be able to access it by using a Web browser.

**The quickest way to discover the cameras in the network** is to use the simplest network search, built in the Windows system – just by pressing the “Network” icon, all the cameras of the local area network will be discovered by Windows thanks to the UPnP function support of our cameras.

In the example below, we successfully the camera model that we had just connected to the network.

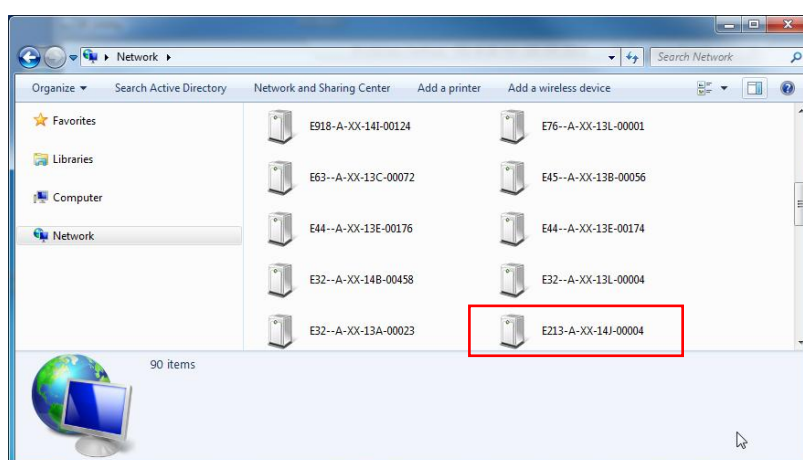

Double-click the mouse button on the camera model, the default browser of the PC is automatically launched and the IP address of the target camera is already filled in the address bar of the browser.

If you work with our cameras regularly, then **there is even a better way to discover the cameras in the network** – by using **IP Utility**. The IP Utility is a light software tool that can not only discover the cameras, but also list lots of valuable information, such as IP and MAC addresses, serial numbers, firmware versions, etc, and allows quick configuration of multiple devices at the same time.

The IP Utility can be downloaded for free from [http://www.acti.com/IP\\_Utility](http://www.acti.com/IP_Utility).

With just one click, you can launch the IP Utility and there will be an instant report as follows:

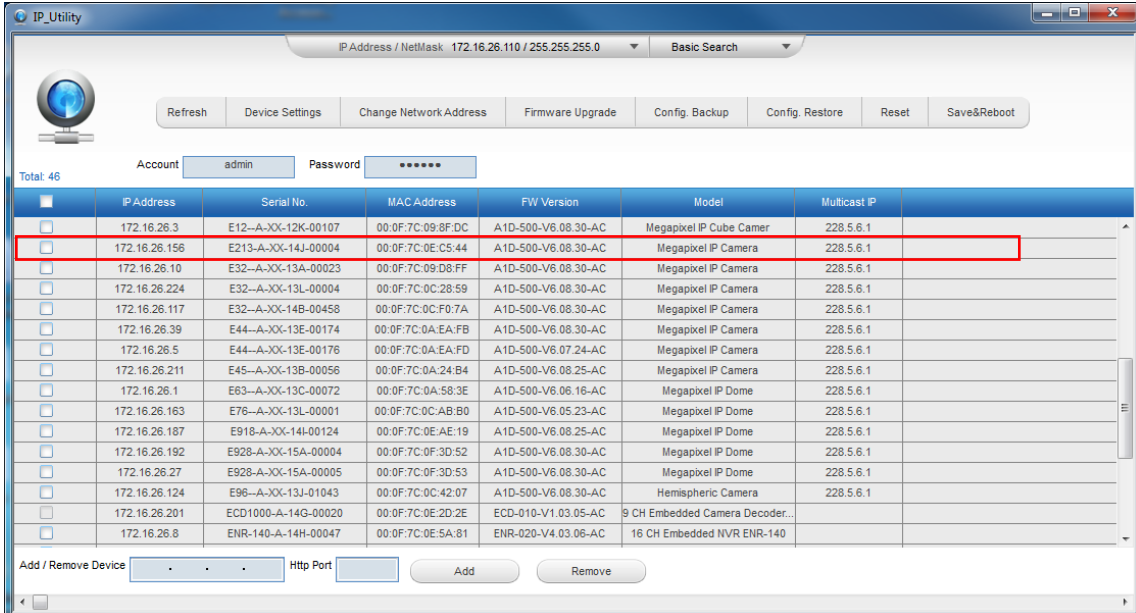

	IP Address	Serial No.	MAC Address	FW Version	Model	Multicast IP
<input type="checkbox"/>	172.16.26.3	E12-A-XX-12K-00107	00:0F:7C:09:0F:DC	A1D-500-V6.08.30-AC	Megapixel IP Cube Camer	228.5.6.1
<input type="checkbox"/>	172.16.26.156	E213-A-XX-14J-00004	00:0F:7C:0E:C5:44	A1D-500-V6.08.30-AC	Megapixel IP Camera	228.5.6.1
<input type="checkbox"/>	172.16.26.10	E32-A-XX-13A-00023	00:0F:7C:09:D8:FF	A1D-500-V6.08.30-AC	Megapixel IP Camera	228.5.6.1
<input type="checkbox"/>	172.16.26.224	E32-A-XX-13L-00004	00:0F:7C:0C:28:59	A1D-500-V6.08.30-AC	Megapixel IP Camera	228.5.6.1
<input type="checkbox"/>	172.16.26.117	E32-A-XX-14B-00458	00:0F:7C:0C:F0:7A	A1D-500-V6.08.30-AC	Megapixel IP Camera	228.5.6.1
<input type="checkbox"/>	172.16.26.39	E44-A-XX-13E-00174	00:0F:7C:0A:EA:FB	A1D-500-V6.08.30-AC	Megapixel IP Camera	228.5.6.1
<input type="checkbox"/>	172.16.26.5	E44-A-XX-13E-00176	00:0F:7C:0A:EA:FD	A1D-500-V6.07.24-AC	Megapixel IP Camera	228.5.6.1
<input type="checkbox"/>	172.16.26.211	E45-A-XX-13B-00056	00:0F:7C:0A:24:B4	A1D-500-V6.08.25-AC	Megapixel IP Camera	228.5.6.1
<input type="checkbox"/>	172.16.26.1	E63-A-XX-13C-00072	00:0F:7C:0A:58:3E	A1D-500-V6.06.16-AC	Megapixel IP Dome	228.5.6.1
<input type="checkbox"/>	172.16.26.163	E76-A-XX-13L-00001	00:0F:7C:0C:AB:B0	A1D-500-V6.05.23-AC	Megapixel IP Dome	228.5.6.1
<input type="checkbox"/>	172.16.26.187	E918-A-XX-14-00124	00:0F:7C:0E:AE:19	A1D-500-V6.08.25-AC	Megapixel IP Dome	228.5.6.1
<input type="checkbox"/>	172.16.26.192	E928-A-XX-15A-00004	00:0F:7C:0F:3D:52	A1D-500-V6.08.30-AC	Megapixel IP Dome	228.5.6.1
<input type="checkbox"/>	172.16.26.27	E928-A-XX-15A-00005	00:0F:7C:0F:3D:53	A1D-500-V6.08.30-AC	Megapixel IP Dome	228.5.6.1
<input type="checkbox"/>	172.16.26.124	E96-A-XX-13J-01043	00:0F:7C:0C:42:07	A1D-500-V6.08.30-AC	Hemispheric Camera	228.5.6.1
<input type="checkbox"/>	172.16.26.201	ECD1000-A-14G-00020	00:0F:7C:0E:2D:2E	ECD-010-V1.03.05-AC	9 CH Embedded Camera Decoder...	
<input type="checkbox"/>	172.16.26.8	ENR-140-A-14H-00047	00:0F:7C:0E:5A:81	ENR-020-V4.03.06-AC	16 CH Embedded NVR ENR-140	

You can quickly notice the camera model in the list. Click on the IP address to automatically launch the default browser of the PC with the IP address of the target camera filled in the address bar of the browser already.

## Use the default IP address of a camera:

If there is no DHCP server in the given network, the user may have to assign the IP addresses to both PC and camera manually to make sure they are in the same network segment.

When the camera is plugged into network and it does not detect any DHCP services, it will automatically assign itself a default IP:

## 192.168.0.100

Whereas the default port number would be **80**. In order to access that camera, the IP address of the PC has to be configured to match the network segment of the camera.

## Manually adjust the IP address of the PC:

In the following example, based on Windows 7, we will configure the IP address to **192.168.0.99** and set Subnet Mask to **255.255.255.0** by using the steps below:

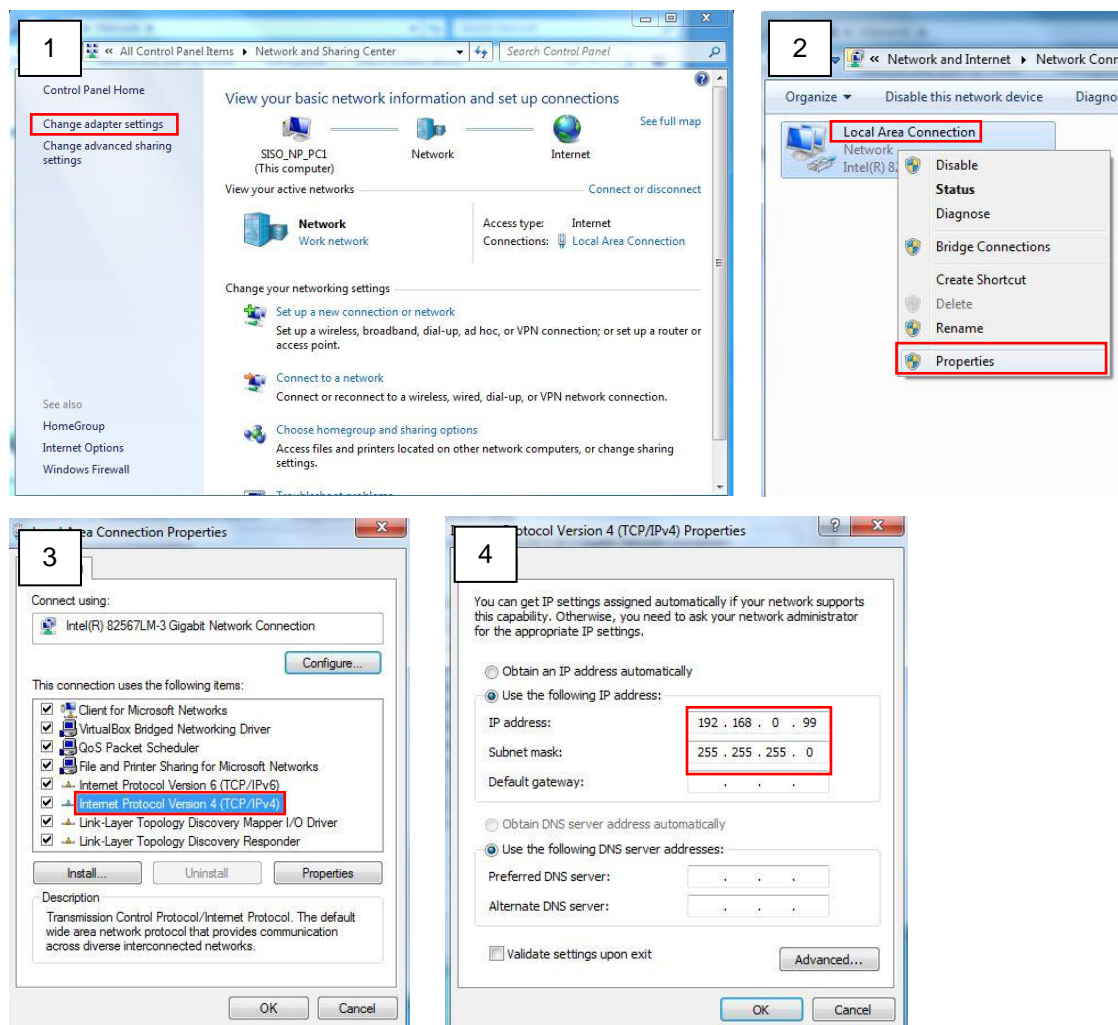

**Manually adjust the IP addresses of multiple cameras:**

If there are more than 1 camera to be used in the same local area network and there is no DHCP server to assign unique IP addresses to each of them, all of the cameras would then have the initial IP address of **192.168.0.100**, which is not a proper situation for network devices – all the IP addresses have to be different from each other. The easiest way to assign cameras the IP addresses is by using **IP Utility**:

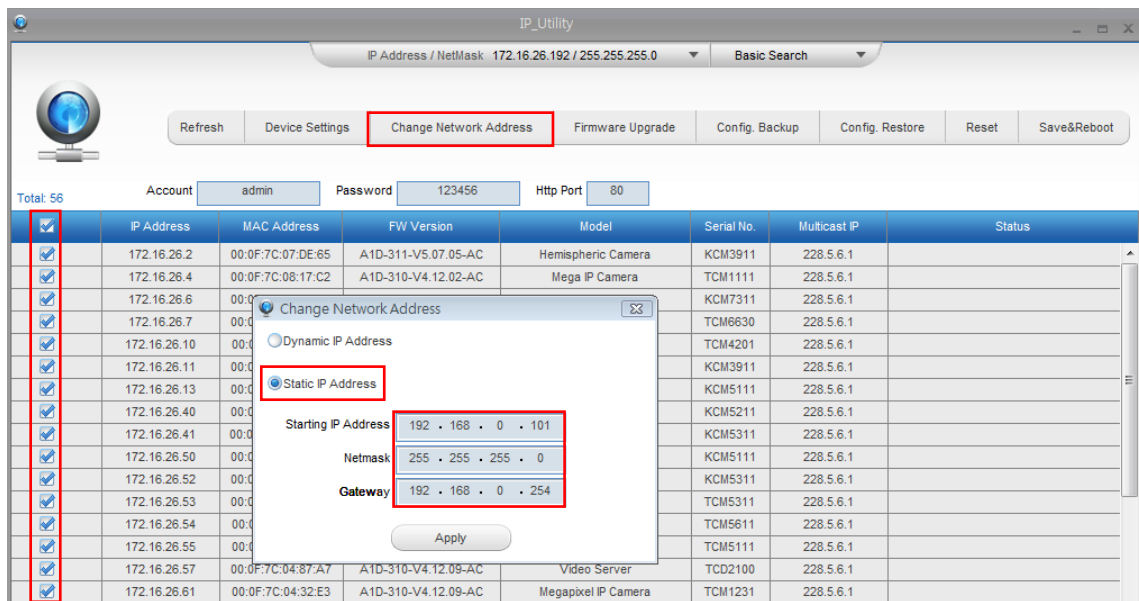

With the procedure shown above, all the cameras will have unique IP addresses, starting from 192.168.0.101. In case there are 20 cameras selected, the last one of the cameras would have the IP 192.168.0.120.

Later, by pressing the “Refresh” button of the IP Utility, you will be able to see the list of cameras with their new IP addresses.

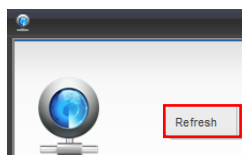

Please note that it is also possible to change the IP addresses manually by using the Web browser. In such case, please plug in only one camera at a time, and change its IP address by using the Web browser before plugging in the next one. This way, the Web browser will not be confused about two devices having the same IP address at the same time.

## Access the Camera

Now that the camera and the PC are both having their unique IP addresses and are under the same network segment, it is possible to use the Web browser of the PC to access the camera.

You can use **any of the browsers** to access the camera, however, the full functionality is provided only for **Microsoft Internet Explorer**.

The browser functionality comparison:

Functionality	Internet Explorer	Other browsers
Live Video	Yes	Yes*
Live Video Area Resizable	Yes	No
PTZ Control	Yes	Yes
Capture the snapshot	Yes	Yes
Video overlay based configuration (Motion Detection regions, Privacy Mask regions)	Yes	No
All the other configurations	Yes	Yes

\* When using non-Internet Explorer browsers, free third-party software plug-ins must be installed to the PC first to be able to get the live video feed from the camera:

Browser	Required Plug-In
Safari	QuickTime ( <a href="http://www.apple.com/quicktime/download/">http://www.apple.com/quicktime/download/</a> )
Other non-Internet Explorer browsers	Basic VLC Media Player ( <a href="http://www.videolan.org">http://www.videolan.org</a> )

**Disclaimer Notice:** *The camera manufacturer does not guarantee the compatibility of its cameras with VLC player or QuickTime – since these are third party softwares. The third party has the right to modify their utility any time which might affect the compatibility. In such cases, please use Internet Explorer browser instead.*

When using Internet Explorer browser, the ActiveX control for video stream management will be downloaded from the camera directly – the user just has to accept the use of such control when prompted so. No other third party utilities are required to be installed in such case.

The following examples in this manual are based on Internet Explorer browser in order to cover all functions of the camera.

Assuming that the camera's IP address is **192.168.0.100**, you can access it by opening the Web browser and typing the following address into Web browser's address bar:

**http://192.168.0.100**

Upon successful connection to the camera, the user interface called **Web Configurator** would appear together with the login page. The HTTP port number was not added behind the IP address since the default HTTP port of the camera is 80, which can be omitted from the address for convenience.

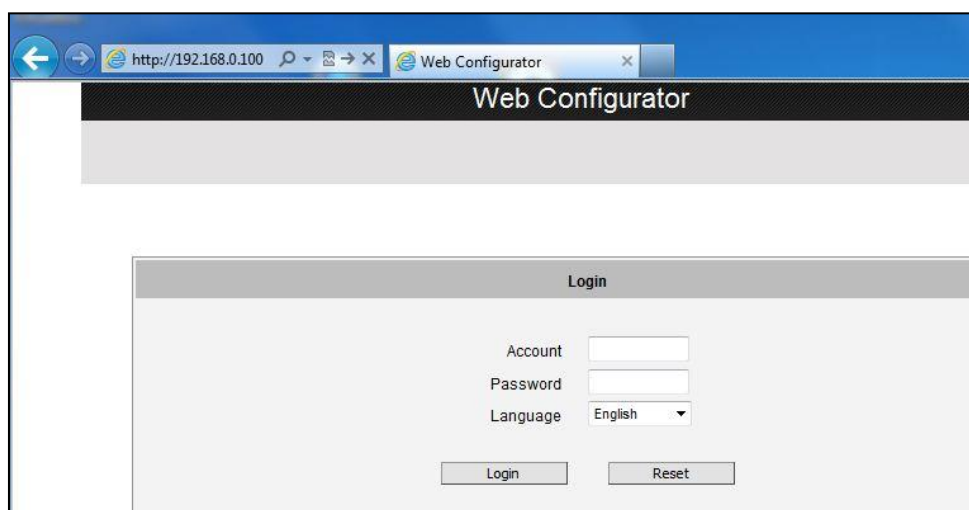

Before logging in, you need to know the factory default Account and Password of the camera.

Account: **Admin**

Password: **123456**

For further operations, please refer to the **Firmware User Manual**.



Copyright © 2015, ACTi Corporation All Rights Reserved

7F, No. 1, Alley 20, Lane 407, Sec. 2, Ti-Ding Blvd., Neihu District, Taipei, Taiwan 114, R.O.C.

TEL : +886-2-2656-2588    FAX : +886-2-2656-2599

Email: [sales@acti.com](mailto:sales@acti.com)