

E927M

10MP Outdoor Mini Fisheye Dome with D/N, Adaptive IR, Basic WDR, Fixed Lens



- 10 Megapixel with 1080p
- Day & Night with Adaptive IR LED
- Fixed Lens with f1.37 mm / F2.0
- Basic WDR (70 dB)
- 7 fps at 3648 x 2736
- 180/360° Fisheye View
- Weatherproof (IP68), Vandal Proof (IK10) and Vibration Proof (EN50155)

PHOTO INDICATION

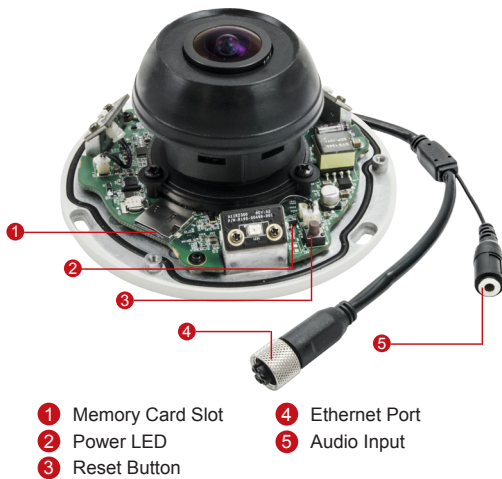

- 1 Memory Card Slot
- 2 Power LED
- 3 Reset Button
- 4 Ethernet Port
- 5 Audio Input

DIMENSION DIAGRAM

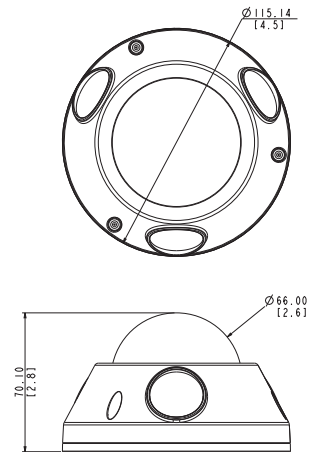



Unit: mm [inch]

ACCESSORY OPTIONS

Power Supply	
PPOE-0001	 PoE Injector IEEE 802.3af compliant, AC 100~240V, with universal connectors

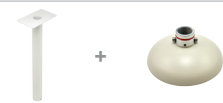
Dome Cover	
PDCX-1112	 Vandal proof smoked dome cover for E924(M)~E929(M)

Popular Mounting Solutions	
Surface	Accessories not required
Wall	PMAX-0316 
Pendant	PMAX-0111 PMAX-1400 
Gang Box	PMAX-0805 
NPT Standard Mounts	PMAX-0809 PMAX-1400 

* For more mounting solutions, please refer to Mounting Accessory Selector on www.acti.com

PRODUCT SPECIFICATION**E927M****• Device**

Device Type	Outdoor Mini Fisheye Dome
Image Sensor	Progressive Scan CMOS
Sensor Size	1/2.3"
Effective Pixels	3856 (H) x 2764 (V) (10.66 MP)
Horizontal Resolution	1450 TVL
Day / Night	Yes
Low Light Sensitivity	Standard
Minimum Illumination	Color: 0.1 lux at F2.0 (30 IRE, 2400°K); B/W: 0 lux at F2.0
Mechanical IR Cut Filter	Yes
IR Sensitivity Range	700 - 1100nm
IR LED	Adaptive IR LED x 3 (850 nm)
IR Working Distance	10 m (0 lux, 30 IRE, Gain 255, Manual shutter mode)
Electronic Shutter	1/5 ~ 1/2,000 sec (manual mode); 1/5 ~ 1/10,000 sec (auto mode)
S/N Ratio	52 dB

• Lens

Focal Length / Aperture	Fixed focal, f1.37 mm / F2.0
Iris	Fixed iris
Focus	Fixed focus
Lens Mount	Board mount
Horizontal Viewing Angle	187° (overview area), 114.1° (high detail area)
Viewing Angle Adjustment	Rotate: ±90°

• Video

Compression	H.264 (Baseline / Main / High profile), MJPEG
Max. Resolution vs. Frame Rate	7 fps at 3648 x 2736; 7 fps at 2592 x 1944; 7 fps at 2048 x 1536; 7 fps at 1440 x 1080; 7 fps at 1280 x 960; 7 fps at 800 x 600; 7 fps at 640 x 480; 7 fps at 320 x 240
Mode	Fisheye view, 180° /360° Panorama, ePTZ
Multi-Streaming	Simultaneous dual streams based on two configurations
Bit Rate	28 Kbps - 6 Mbps (per stream)
Bit Rate Mode	Constant, Variable
Image Enhancement	Basic WDR (70 dB); White balance: automatic, hold and manual; Brightness; Contrast; Sharpness (auto); Auto gain control; 2D+3D digital noise reduction; Flickerless
Privacy Mask	4 configurable regions
Text Overlay	User defined text on video
Image Orientation	Image flip and mirror

• Audio

Audio Input	Line-in and mic-in, cable with 3.5mm phone jack
-------------	---

• Network

Protocol & Service	TCP, UDP, HTTP, HTTPS, DHCP, PPPoE, RTP, RTSP, IPv4, IPv6, DNS, DDNS, NTP, ICMP, ARP, IGMP, SMTP, FTP, UPnP, SNMP, Bonjour
Ethernet Port	1, Ethernet (10/100 Base-T), M12 (female, D-Coding, PoE Type A)
Security	IP address filtering; HTTPS encryption; Password protected user levels; Anonymous login; IEEE 802.1X network access control

• Alarm

Alarm Trigger	Video motion detection (3 regions); Sound detection
Alarm Response	Notify control center; Change camera settings; Command other devices; E-mail notification with snapshots; Save video or snapshot to local storage; Upload video or Snapshot to FTP

• Interface

Local Storage	MicroSDHC/MicroSDXC memory card slot (card not included)
---------------	--

• General

Power Source / Consumption	PoE Class 2 (IEEE802.3af) / 4.8 W
Weight	475 g (1.05 lb)
Dimensions (Ø x H)	115 mm x 70 mm (4.5" x 2.8")
Environmental Casing	Weatherproof (IP68 rated); Vandal proof (IK10 rated); Vibration Proof (EN50155); Transparent dome cover
Mount Type	Surface, Wall, Pendant, Gang box
Starting Temperature	-20°C ~ 50°C (-4°F ~ 122°F)
Operating Temperature	-20°C ~ 50°C (-4°F ~ 122°F)
Operating Humidity	10% ~ 85% RH
Approvals	CE (EN 55022 Class B, EN 55024), FCC (Part15 Subpart B Class B), IK10, IP68, NEMA 4X, EN50155, UL (for optional PoE injector)

• Integration

Unified Solution	Fully compatible with ACTi software
ISV Integration	Software Development Kit (SDK) available; ONVIF compliant
GPS Position	Manual setting
Firmware Access Browser	Microsoft Internet Explorer 8.0 or newer (full functionality); Safari with QuickTime installed, and other browsers with VLC installed (partial functionality)