



Zoom Bullet Series Hardware Manual

B41, B44, B45, B47, B410
I44, I45

2015/01/08



ACTi
Connecting Vision

Table of Contents

Precautions	4
Safety Instructions	6
Introduction	7
The List of Models	7
Package Contents.....	8
Physical Description	10
Mounting Options	12
Installation Procedures	13
Step 1: Prepare for Installation.....	13
Step 2: Attach the Sunshield	14
Step 3: Install the Camera.....	15
Step 4: Waterproof and Connect the Network Cable	15
Step 5: Connect to Network.....	16
Step 6: Access Camera Live View	16
Step 7: Adjust the Viewing Angle	17
Waterproof Solution Using the “Pigtail”	18
How to Use the Female Cable Gland.....	19
How to Use the Female Conduit Gland.....	22
Waterproof Solution Using the Camera Connectors	26
How to Use the Male Cable Gland (Optional)	28
How to Use the Male Conduit Gland	32
Other Connections.....	36
Connecting a Power Adapter (Optional)	36

Connecting DI/DO and Audio Devices (Optional) 38
 How to Connect DI/DO Devices 38
 How to Connect Audio Devices 41

Other Adjustments and Accessories 42

How to Remove the “Pigtail” 42
How to Insert a Memory Card 45
 How to Insert the Memory Card 45
 How to Remove the Memory Card 45

Accessing the Camera 46

Configure the IP Addresses 46
Access the Camera 50

Precautions

Read these instructions

You should read all the safety and operating instructions before using this product.

Heed all warnings

You must adhere to all the warnings on the product and in the instruction manual. Failure to follow the safety instruction given may directly endanger people, cause damage to the system or to other equipment.

Servicing

Do not attempt to service this video device yourself as opening or removing covers may expose you to dangerous voltage or other hazards. Refer all servicing to qualified service personnel.

Trademarks

All names used in this manual are probably registered trademarks of respective companies.

Liability

Every reasonable care has been taken during the writing of this manual. Please inform your local office if you find any inaccuracies or omissions. We cannot be held responsible for any typographical or technical errors and reserve the right to make changes to the product and manuals without prior notice.

Federal Communications Commission Statement



This equipment has been tested and found to comply with the limits for a class B digital device, pursuant to Part 15 of the FCC Rules. These limits are designed to provide reasonable protection against harmful interference in a residential installation. This equipment generates, uses, and can radiate radio frequency energy and, if not installed and used in accordance with the instructions, may cause harmful interference to radio communications. However, there is no guarantee that interference will not occur in a particular installation. If this equipment does cause harmful interference to radio or television reception, which can be determined by turning the equipment off and on, the user is encouraged to try to correct the interference by one or more of the following measures:

- Reorient or relocate the receiving antenna.
- Increase the separation between the equipment and receiver.
- Connect the equipment into an outlet on a circuit different from that to which the receiver is connected.
- Consult the dealer or an experienced radio/TV technician for help.

Warning: Changes or modifications to the equipment that are not expressly approved by the responsible party for compliance could void the user's authority to operate the equipment.

European Community Compliance Statement



This product has been tested and found to comply with the limits for Class B Information Technology Equipment according to European Standard EN 55022 and EN 55024. In a domestic environment, this product may cause radio interference in which cause the user may be required to take adequate measures.

Safety Instructions

Cleaning

Disconnect this video product from the power supply before cleaning.

Attachments

Do not use attachments not recommended by the video product manufacturer as they may cause hazards.

Do not use accessories not recommended by the manufacturer

Only install this device in a dry place protected from weather

Servicing

Do not attempt to service this video product yourself. Refer all servicing to qualified service personnel.

Damage Requiring service

Disconnect this video product from the power supply immediately and refer servicing to qualified service personnel under the following conditions.

- 1) When the power-supply cord or plug is damaged
- 2) If liquid has been spilled, or objects have fallen into the video product.
- 3) If the inner parts of video product have been directly exposed to rain or water.
- 4) If the video product does not operate normally by following the operating Instructions in this manual. Adjust only those controls that are covered by the instruction manual, as an improper adjustment of other controls may result in damage, and will often require extensive work by a qualified technician to restore the video product to its normal operation.







Safety Check

Upon completion of any service or repairs to this video product, ask the service technician to perform safety checks to determine if the video product is in proper operating condition.

Introduction

The List of Models



This hardware manual contains the following models:

B41		5MP Zoom Bullet with D/N, Adaptive IR, Basic WDR, 12x Zoom lens
B44		1.3MP Zoom Bullet with D/N, Adaptive IR, Basic WDR, SLLS, 10x Zoom lens
B45		2MP Zoom Bullet with D/N, Adaptive IR, Basic WDR, SLLS, 10x Zoom lens
B47		3MP Zoom Bullet with D/N, Adaptive IR, Superior WDR, 12x Zoom lens
B410		10MP Zoom Bullet with D/N, Adaptive IR, Basic WDR, 10x Zoom lens
I44		1MP Zoom Bullet with D/N, Adaptive IR, Extreme WDR, ELLS, 30x Zoom lens
I45		2MP Zoom Bullet with D/N, Adaptive IR, Extreme WDR, ELLS, 30x Zoom lens

From the installation perspective these models are very similar; therefore you can use one manual for all of them.

Package Contents

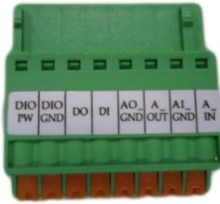
Camera	Sunshield	Sunshield Screws
		
Hexagon Screwdriver	Camera Base Wrench	Bracket Wrench
		
Female Conduit Gland	Female Cable Gland	Washer
		
Male Conduit Gland	Male Cable Gland (Optional)	Drill Template Sticker
		

Terminal Block (for Power)	Terminal Block (for Audio and DI/DO)	Quick Installation Guide
		
Warranty Card		
		

NOTE: The pictures are for reference only. Actual items may slightly vary.

Physical Description

Exterior View



Connectors View



NOTE: The connectors are hidden under the housing cover.

1) Ethernet Ports

The Ethernet port (1a) of the cable-out or “pigtail” connects to a network using an Ethernet cable.

The Ethernet port (1b) on the housing connects the cable-out or “pigtail” to the camera.

NOTE: It is possible to replace the “pigtail” with a standard Ethernet cable by disconnecting the pigtail and connecting the preferred cable to this port.

2) Memory Card Slot

Insert a memory card into this slot for local recording purposes. See [How to Insert a Memory Card](#) on page 45 for more information.

NOTE: Supports microSDHC and microSDXC cards.

3) Digital Input / Output (DI/DO) and Audio Input / Output

This connector connects to digital input or output devices, such as an alarm trigger, panic button, etc., as well as audio input and output devices, such as microphones and speakers. Digital Input (DI) and Digital Output (DO) devices are used in applications like motion detection, event triggering, alarm notifications, etc. See [Connecting DI/DO and Audio Devices \(Optional\)](#) on page 38 for information.

4) DC 12V Power Input

In case the camera is connected to a non-PoE (Power over Ethernet) switch, use this connector to connect the camera to an external power adapter (not included). See [Connecting a Power Adapter \(Optional\)](#) on page 36 for more information.

5) Reset Button

The purpose of reset button is to restore the factory default settings of the camera, including the administrator's password.

The reset button can be used for following purposes:

- The administrator's password has been forgotten and therefore the camera cannot be accessed.
- In case of IP address, mask, or allow/deny filter related issues, resulting with inability to modify these settings.
- In case of connectivity issues or abnormal video quality.

How to do the reset properly?

Press and hold the reset button for 5 seconds or until the power LED lights up.



6) Power LED

The Power LED lights red when the camera is powered on and goes off once the camera boot-up process is complete.

NOTE: For typical use, the power LED is hidden inside the housing and cannot be seen. However, knowing how the power LED works is essential when troubleshooting or doing a reset.

Mounting Options

There are several mounting options that you can use to install the camera. Select the most suitable solution for your installation environment.

Mount Types	Accessories
Wall Mount	Suitable when mounting the camera directly on walls using the integrated bracket. See <i>Installation Procedures</i> on page 13.
Gang Box Converter	Suitable for locations which require the use of gang boxes. The Gang Box Converter is attached to the gang box while the camera with its bundled bracket is installed on the Gang Box Converter. All cables are hidden inside the gang box.
	PMAX-0806 
Ceiling Mount	Suitable when mounting the camera on the ceiling. The integrated bracket must be removed from the camera first.
	PMAX-1300 

NOTE:

- For more information about the mounting solutions and accessories, please check the *Mounting Accessory Selector* in our website (<http://www.acti.com/mountingselector>).
- The above mounting accessories are not included in the package. Contact your sales agents to purchase.

Installation Procedures

This section describes the procedures in installing the camera on the wall using the integrated bracket.

IMPORTANT! Before installation, make sure the wall can bear more than the weight of the camera and its bracket.

NOTE: The following procedures and pictures are based on the cable going along the wall; same procedures apply when the cable will pass through the wall, unless otherwise specified.

Step 1: Prepare for Installation

1. Depending on the wall material, purchase applicable screws and screws plugs (as needed) that can hold the camera and bracket weight on the wall.
2. Attach the supplied drill template sticker on the wall.
3. Determine how the cable will be routed: **pass through the wall** or **along the wall**.
 - **If the cable will pass through the wall**, drill the cable hole and the four (4) screw holes on the wall.

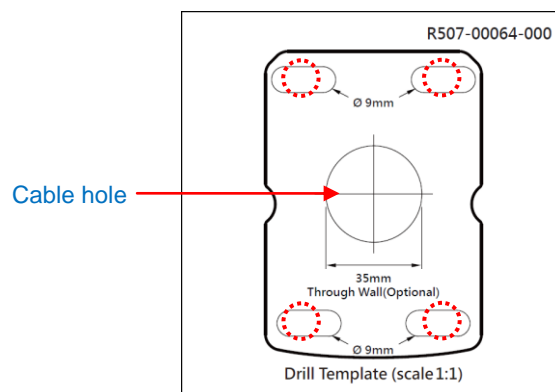

- **If the cable will be routed along the wall**, just drill the four (4) screw holes on the wall.
4. Detach the drill template sticker from the wall and insert the plastic plugs into the screw holes.

Step 2: Attach the Sunshield

1. Loosely secure the supplied screws to attach the sunshield.

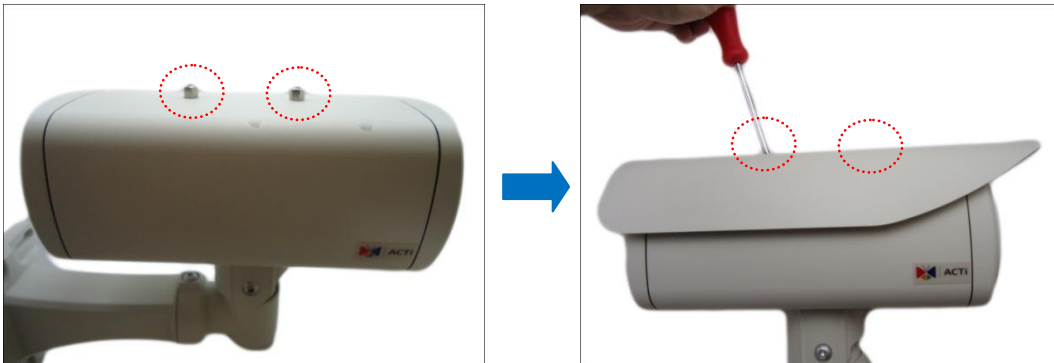

2. Slide to adjust the sunshield to cover the lens as far as possible.



NOTE: The sunshield may have to be adjusted later based on the camera live view.

3. Tighten the screws to secure the sunshield.



Step 3: Install the Camera

1. If the “pigtail” will pass through the wall, follow [Waterproof Solution Using the “Pigtail”](#) on page 18 first and then route the cable through the wall.

If the “pigtail” will go along the wall, route the cable through one of the cable gaps on the bracket.



2. Install the camera to the wall using four (4) screws applicable for the wall material (purchased separately).



NOTE: Make sure the wall can bear more than the weight of the camera with bracket.

Step 4: Waterproof and Connect the Network Cable

See [Waterproof Solution Using the “Pigtail”](#) on page 18.

Step 5: Connect to Network

Connect the other end of the network cable to a switch or injector. Then, connect the switch or injector to a network or PC and a power source. See Power-over-Ethernet (PoE) example connection diagram below.

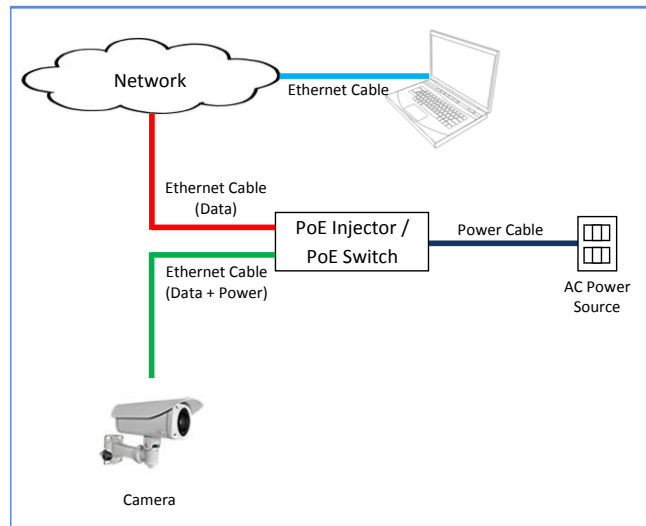

In case of using a non-PoE switch, power up the camera using a power adapter (not supplied). As needed, power up the other connected devices.

Step 6: Access Camera Live View

See [Accessing the Camera](#) on page 46 for more information on how to access the camera live view.

Step 7: Adjust the Viewing Angle

Based on the camera live view, adjust the camera viewing angle. Do the following:

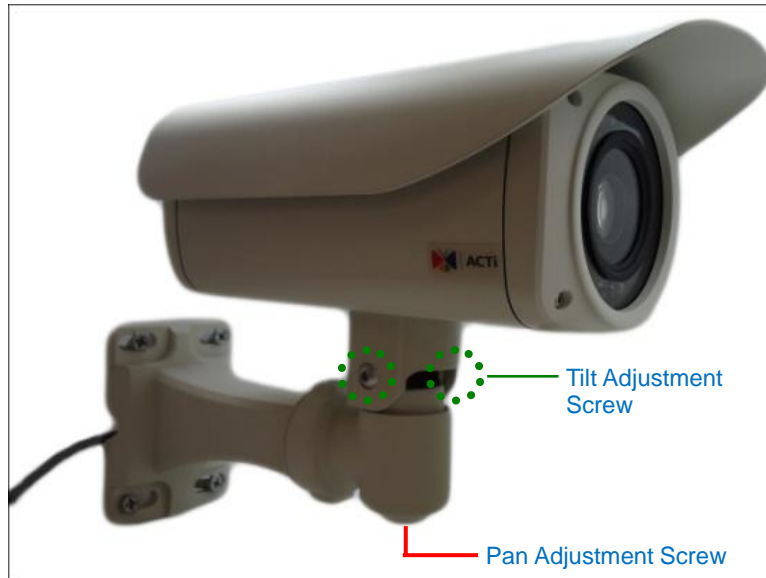

Using the bundled bracket wrench, do the following:

1. Loosen the tilt adjustment screws, adjust the camera tilt, and then tighten back the screws to fix the tilt position.



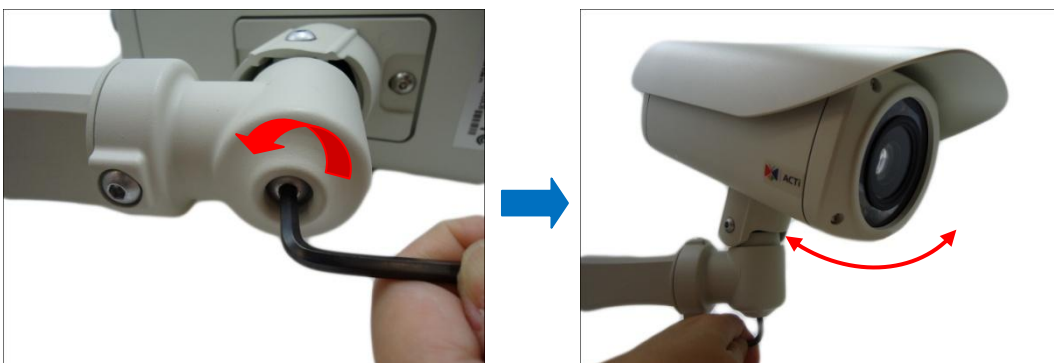

2. Loosen the pan adjustment screw, move the pan direction, and then tighten back the screw to fix the pan position.



Waterproof Solution Using the “Pigtail”

The camera and the pre-installed network cable, “pigtail”, are resistant to salt, water, weak acid, alcohol, oil, grease and other common solvents. However, users must ensure that the cable connection and the network side cable itself are also protected from different environmental factors.

When using a Power-over-Ethernet (PoE) switch or injector, connecting the network cable through the “pigtail” is recommended. In this case, there are two waterproofing methods.



Bundled Accessory	Description
<p><i>Female Cable Gland</i></p> 	<p>Use this solution when connecting an Exterior-grade Ethernet cable between the camera and a Power-over-Ethernet (PoE) switch or injector. See How to Use the Female Cable Gland on page 19.</p>
<p><i>Female Conduit Gland</i></p> 	<p>Use this solution when connecting a standard indoor Ethernet cable between the camera and a Power-over-Ethernet (PoE) switch / injector. A flexible conduit (trade size 1/2”) is required to house the Ethernet cable. See How to Use the Female Conduit Gland on page 22.</p> <p>NOTE: The flex conduit is not included in the package and must be purchased separately.</p>

If other devices, such as a power adapter, digital or audio input or output devices will be connected to the camera, or in some cases, users may require the use of specific cables with customized length, use the back connectors of the camera to connect the cables. See [Waterproof Solution Using the Camera Connectors](#) on page 26 for cabling information.

How to Use the Female Cable Gland

This section describes how to waterproof the cable-out or “pigtail” of the camera using the bundled **female** cable gland. An exterior-grade Ethernet cable is required. The camera may or may not have to be installed first before doing the cable connections (see related installation procedures for details).

Before connection, prepare the following materials:

Female Cable Gland (included in the camera package)	Exterior-Grade Ethernet Cable (not included in the package)
	 <p>NOTE: Exterior-grade cables are already waterproof. <i>Not included in the package.</i></p>
Washer (included in the camera package)	
	

Perform the following to waterproof the “pigtail” using the **female** cable gland:

1. Disassemble the female cable gland as shown below:

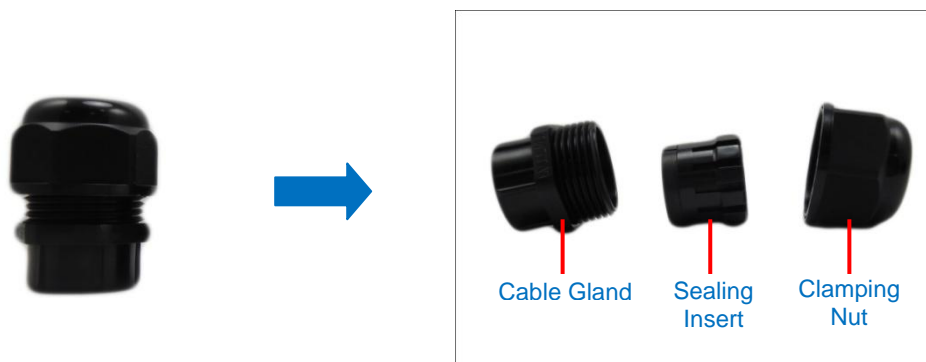

2. Insert the clamping nut into the Ethernet cable.



3. Insert the sealing insert with claw.

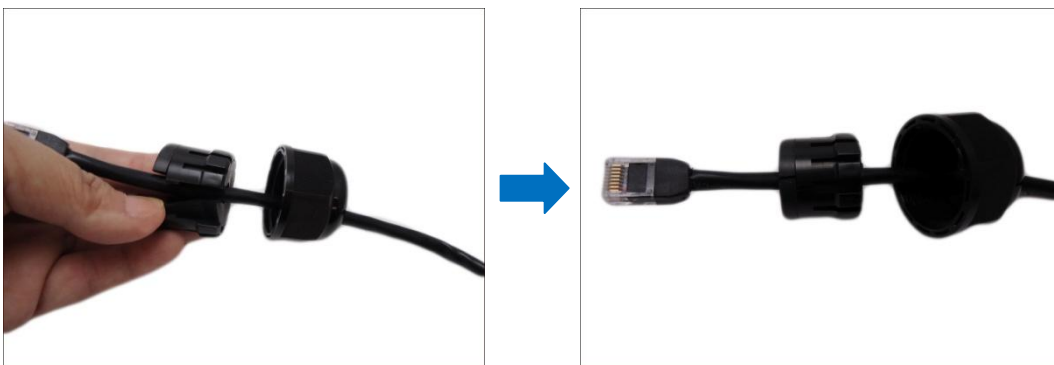

4. Insert the gland body into the Ethernet cable.



5. On the "pigtail" side, insert the washer into the "pigtail".

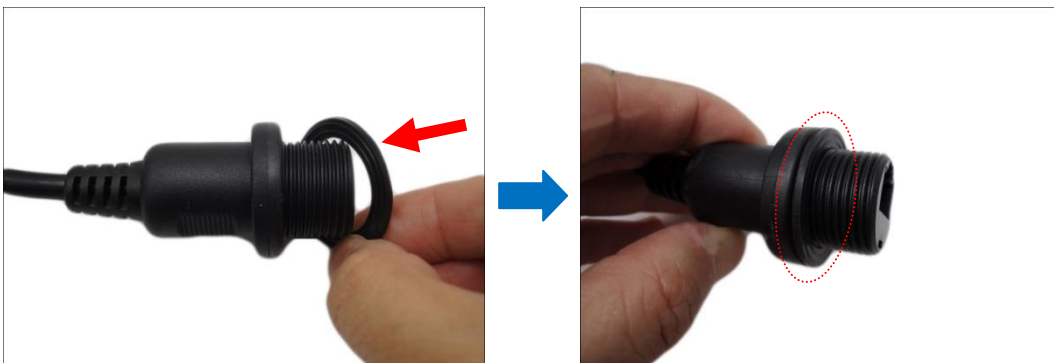

6. Connect the Ethernet cable connector to the “pigtail” connector.



7. Attach the gland body to the “pigtail”.

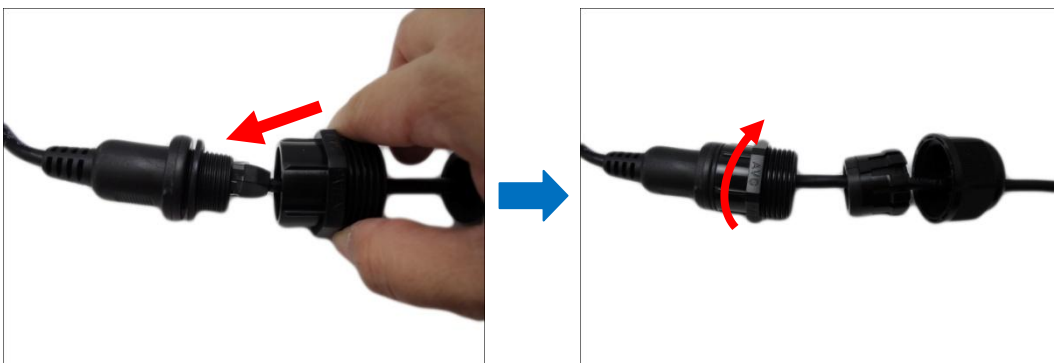

NOTE: Make sure the gland body is tightly attached to the “pigtail” and the washer is secured between them.

8. Insert the sealing insert into the cable gland body and then attach the clamping nut to complete the cable solution.

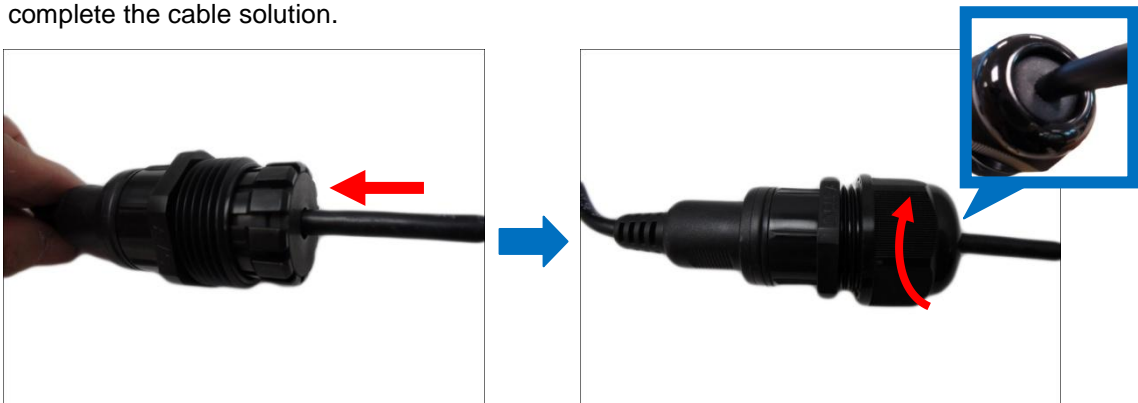

NOTE: Make sure the clamping nut is tightly attached to the cable gland body and the sealing insert is squeezed tightly.

How to Use the Female Conduit Gland

This section describes how to waterproof the cable-out or “pigtail” of the camera using the bundled **female** conduit gland and flexible conduit. This is the recommended solution if an exterior-grade Ethernet cable is not available. The camera may or may not have to be installed first before doing the cable connections (see related installation procedures for details).

Before connection, prepare the following materials:

<p>Female Conduit Gland (included in the camera package)</p>	<p>Flexible Conduit 1/2" Trade size (not included in the package)</p>
	 <p>NOTE: Not included in the package.</p>
<p>Washer (included in the camera package)</p>	<p>Ethernet Cable CAT 5 or CAT 6 (not included in the package)</p>
	

Perform the following to waterproof the “pigtail” using the **female** conduit gland:

1. Disassemble the female conduit gland as shown below:

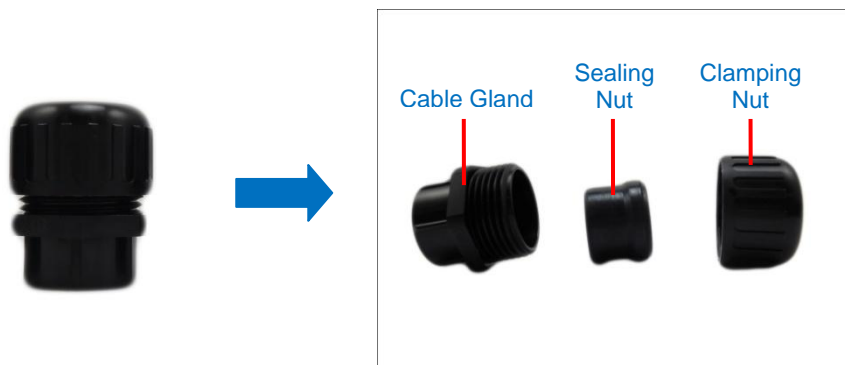

2. Pull the Ethernet cable through the flex conduit. Leave enough length of the cable outside the flex conduit.



3. Insert the clamping nut into through the flex conduit.

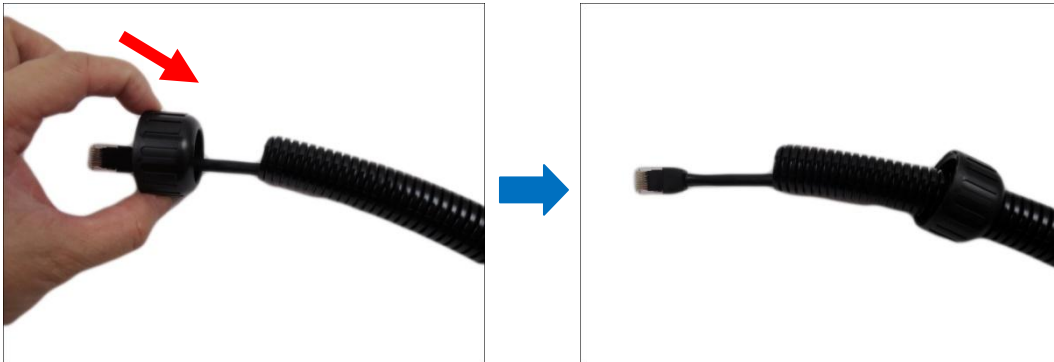

4. Insert the sealing nut and fix it at the end of the flex conduit.

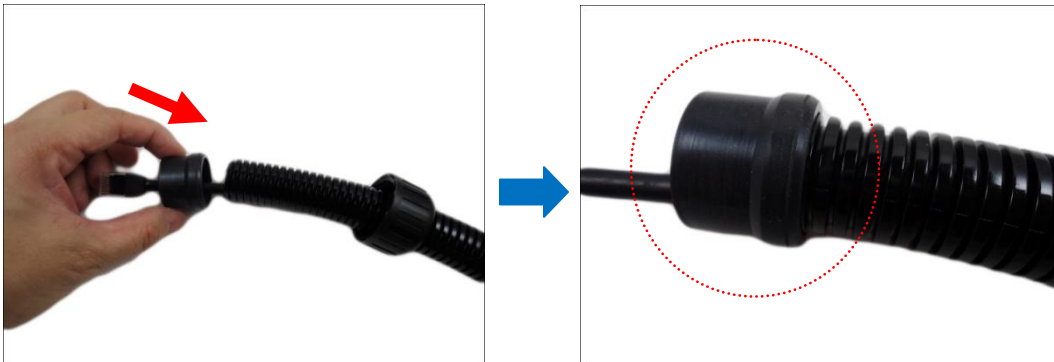

5. Insert the gland body into the Ethernet cable.



- 6. On the “pigtail” side, insert the washer into the “pigtail”.

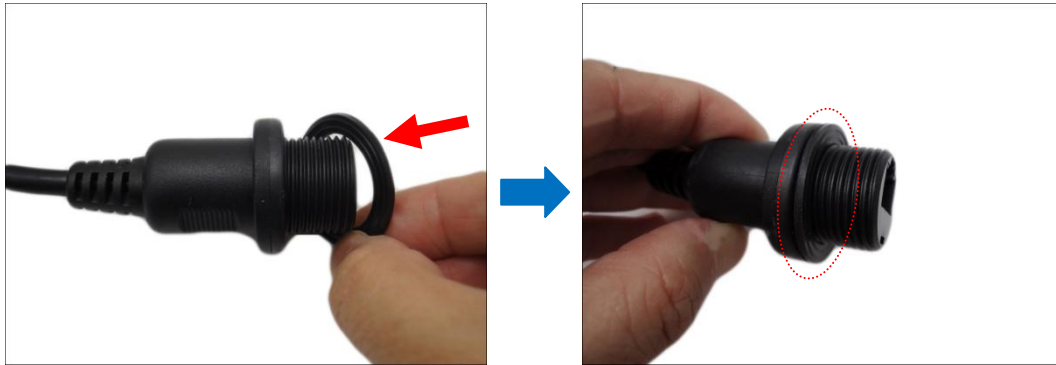

- 7. Connect the Ethernet cable connector to the “pigtail” connector.



- 8. Attach the gland body to the “pigtail”.

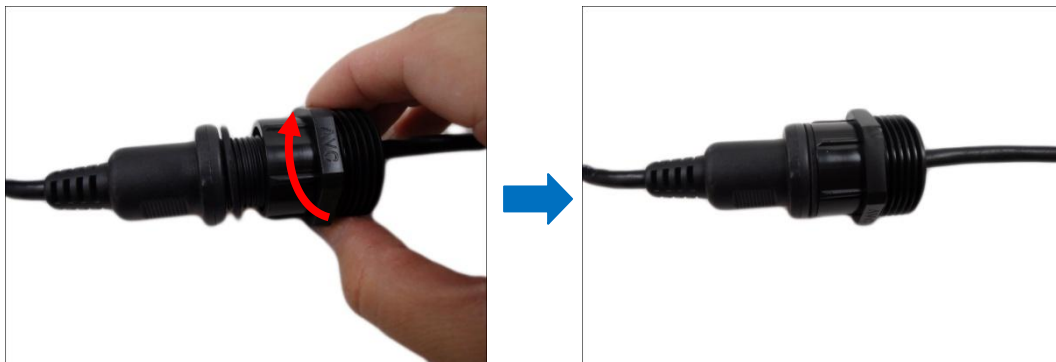

NOTE: Make sure the gland body is tightly attached to the “pigtail” and the washer is secured between them.

9. Push the flex conduit and insert the sealing nut into the gland body.

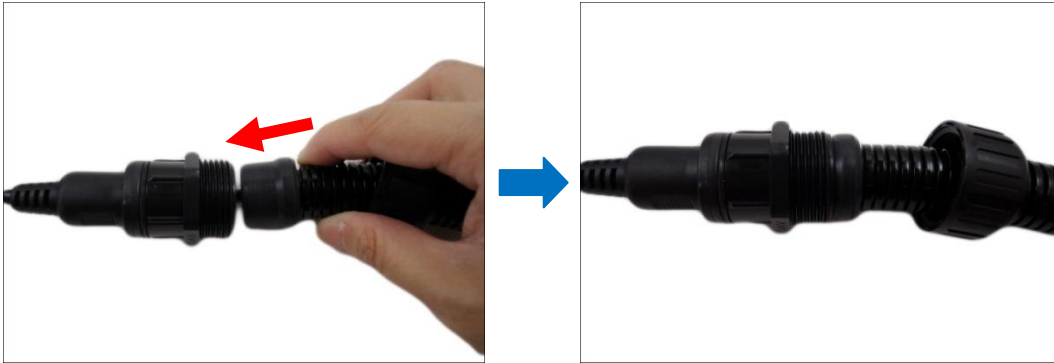

NOTE: Make sure the clamping nut is tightly attached to the cable gland body and the sealing insert is squeezed tightly.



10. Attach the clamping nut to complete the cable solution.



Waterproof Solution Using the Camera Connectors

For more flexible applications, use the connectors at the back of the camera to connect a power adapter or other devices. Or in some cases, users may require the use of specific cables with customized length.

In such cases, use one of the following solutions:

Bundled Accessory	Description
<p data-bbox="236 714 580 748"><i>Male Cable Gland (Optional)</i></p> 	<p data-bbox="627 719 1358 891">Use this solution if the “pigtail” must be replaced with a different cable. The replacement cable must also be Exterior-grade that will be connected to a PoE switch / injector. See How to Use the Male Cable Gland on page 28.</p>
<p data-bbox="236 1146 477 1180"><i>Male Conduit Gland</i></p> 	<p data-bbox="627 1151 1358 1370">Use this solution when connecting other devices, such as audio or digital input / output devices or a power adapter (when PoE is not available). A flexible conduit (trade size 1/2”) is required to house all the cables. See How to Use the Male Conduit Gland on page 32.</p> <p data-bbox="627 1406 1326 1485">NOTE: The flex conduit is not included in the package and must be purchased separately.</p>

Before connecting any devices to the camera connectors, remove the back cover first.

1. Using the bundled hex screwdriver, loosen the four (4) screws to remove the back cover.

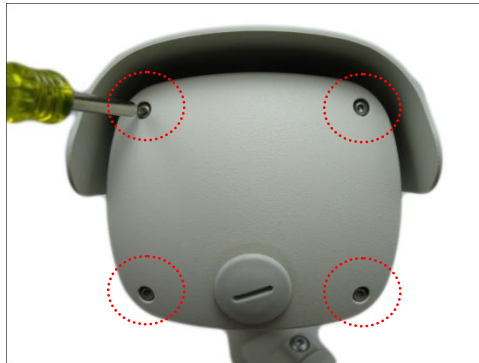

NOTE: The network cable connected to the Ethernet port is the other end of the “pigtail”. If the “pigtail” will not be used to connect the camera to the network, disconnect this cable and remove the “pigtail” from the camera (see [How to Remove the “Pigtail”](#) on page 42 for detailed information).



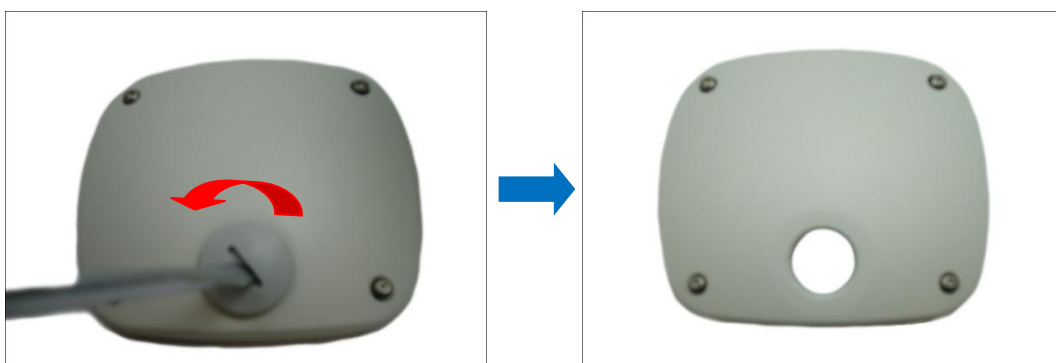

2. Using a coin or screwdriver, remove the cap from the back cover. Then set the back cover aside for later use.



How to Use the Male Cable Gland (Optional)

This section describes how to waterproof the cable using the **male** cable gland. This solution is useful only when you need to replace the cable-out or “pigtail” of the camera (see [How to Remove the “Pigtail”](#) on page 42 for detailed information). For normal applications, the use of “pigtail” is sufficient and there is no need for replacement.

Before connection, prepare the following materials:

Male Cable Gland (included in the camera package)	Exterior-Grade Ethernet Cable (not included in the package)
 <p>A black male cable gland with a circular opening on one side and a threaded section on the other. A blue callout box highlights the circular opening.</p>	 <p>A coiled beige exterior-grade Ethernet cable with RJ45 connectors on both ends.</p> <p>NOTE: Exterior-grade cables are already waterproof. <i>Not included in the package.</i></p>

Perform the following to use the male cable gland solution:

1. Disassemble the male cable gland as shown below:



2. Insert the clamping nut into the Ethernet cable.



3. Insert the sealing insert with claw.

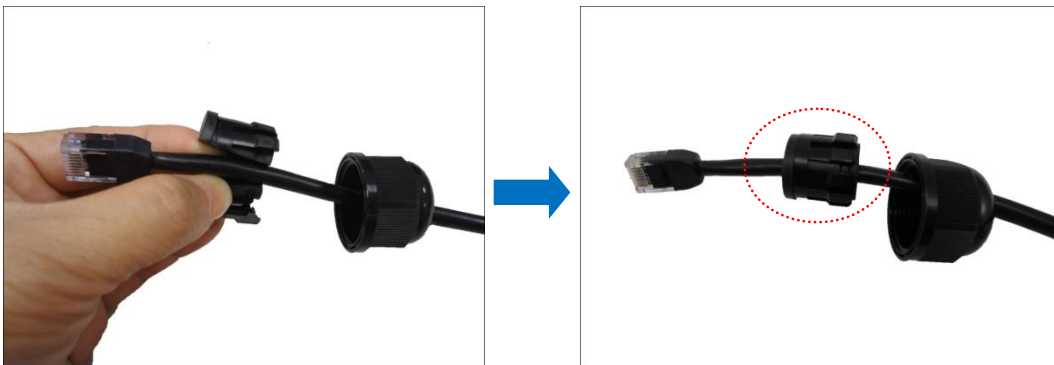

4. Attach the gland body to the hole of the cover.

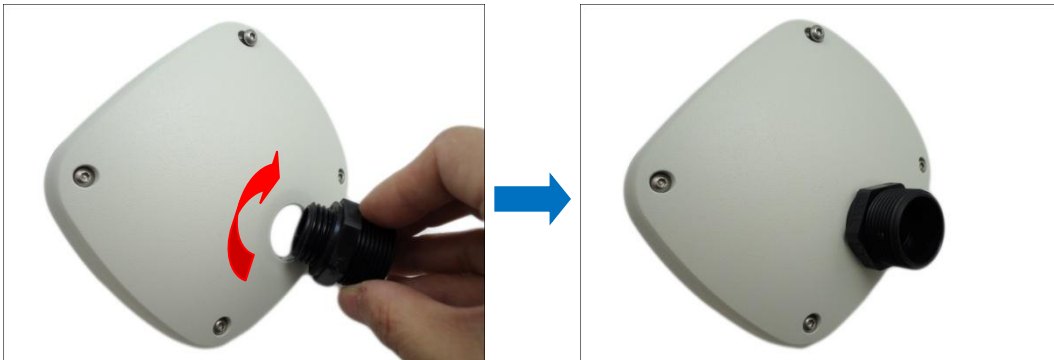

5. Insert the Ethernet cable through the cable gland, and connect it to the Ethernet port of the camera.

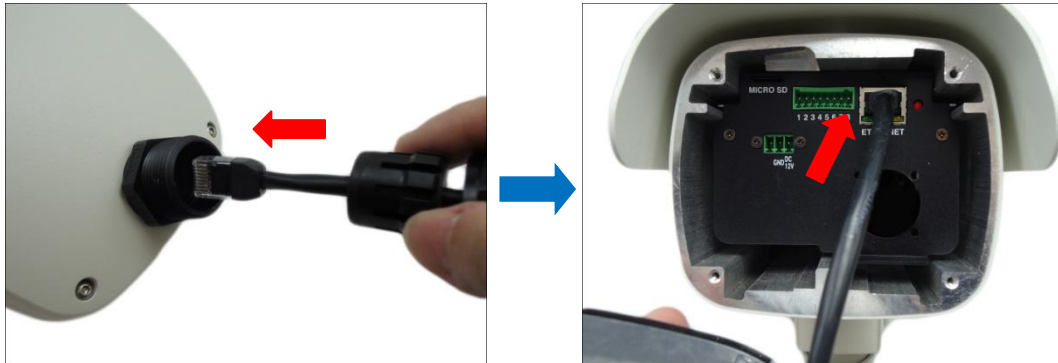

6. Tighten the four (4) screws to secure the camera cover using the hex screwdriver.



NOTE: Make sure the cover rubber (black) is intact and properly aligned to the cover.



7. Insert the sealing insert with claw into the gland body.

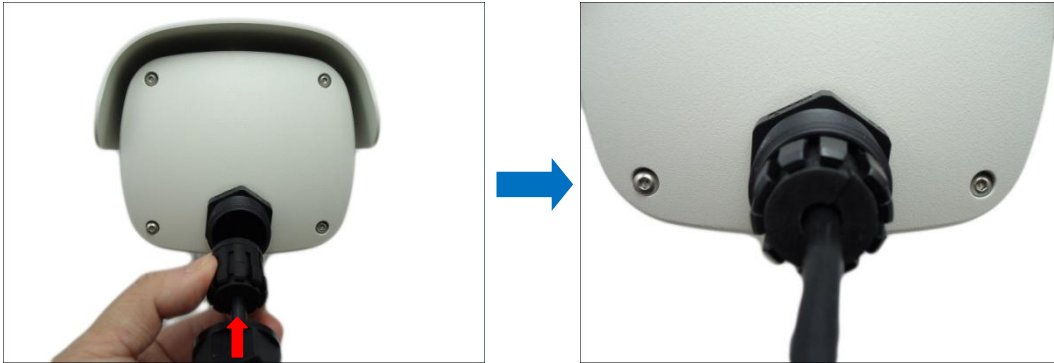

8. Attach the clamping nut to complete the cable solution.



NOTE: Make sure the clamping nut is tightly attached to the cable gland body and the sealing insert is squeezed tightly.

How to Use the Male Conduit Gland

This section describes how to waterproof the cable(s) using the bundled **male** conduit gland and flexible conduit. This is the recommended solution if other devices, such as an audio or digital input/output device will be connected to the camera or when the use of a power adapter is necessary. All the device cables including the power adapter and Ethernet cable can be housed inside the flex conduit. The camera may or may not have to be installed first before doing the cable connections (see related installation procedures for details).

Before connection, prepare the following materials:

Male Conduit Gland (included in the camera package)	Flexible Conduit 1/2" Trade size (not included in the package)
	 <p>NOTE: Not included in the package.</p>

Perform the following to use the male conduit gland solution:

1. Disassemble the male conduit gland as shown below:

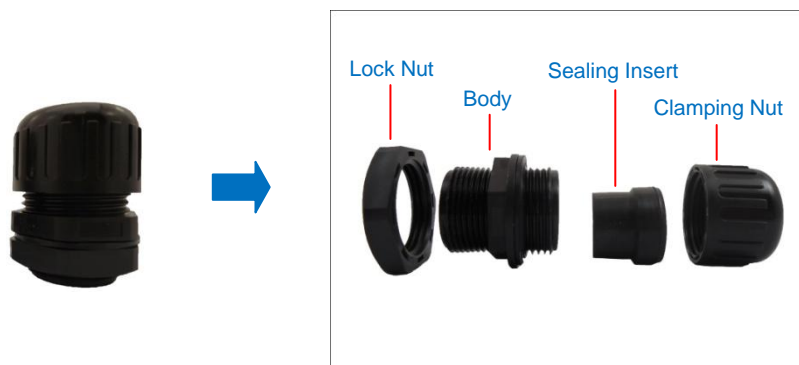

NOTE: In this installation, the conduit gland body can be securely attached to the mount kit; therefore the use of lock nut is not necessary. Please set the lock nut aside.

2. Attach the gland body to the hole of the cover.

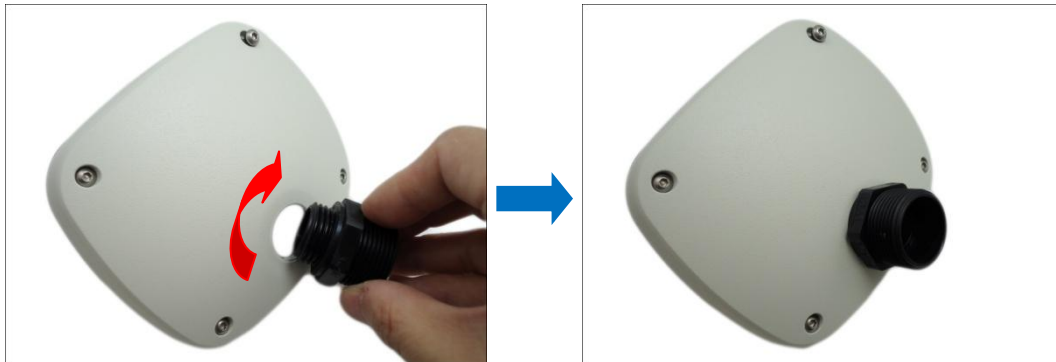

3. Pull enough length of the device cables without connectors through the flex conduit. The terminal blocks will be attached once the cable passes through the gland body and cover later.



4. Insert the clamping nut through the flex conduit.



5. Insert the sealing insert and attach it at the end of the flex conduit.

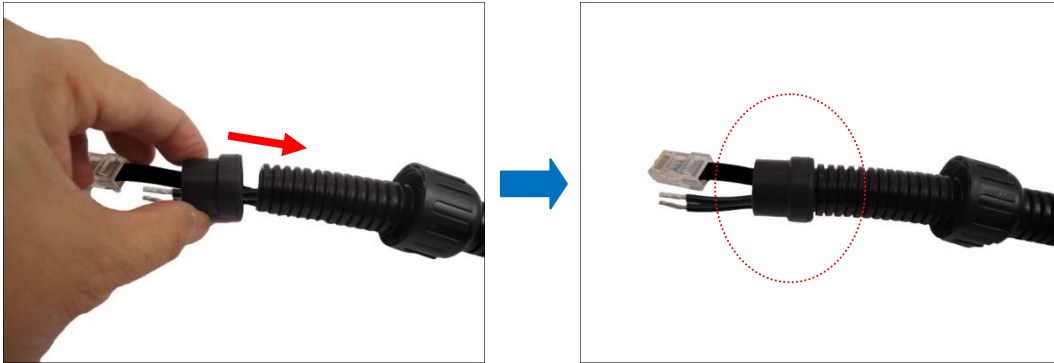

6. Pull the device cables through the gland body.



7. Attach the terminal blocks, see [Other Connections](#) on page 36 for more information.

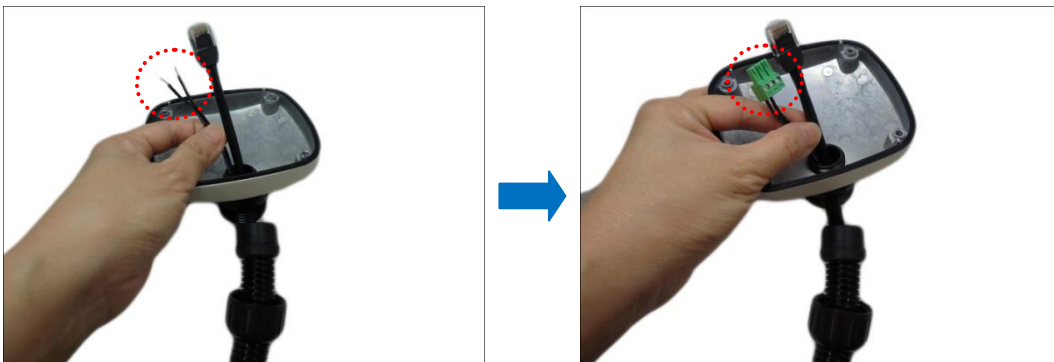

8. Connect the cables to the corresponding connectors on the camera.



- Align the camera cover and tighten the four (4) screws to secure the camera cover using the hex screwdriver.



NOTE: Make sure the cover rubber (black) is intact and properly aligned to the cover.



- Insert the sealing insert with claw into the gland body and then attach the clamping nut to complete the cable solution.

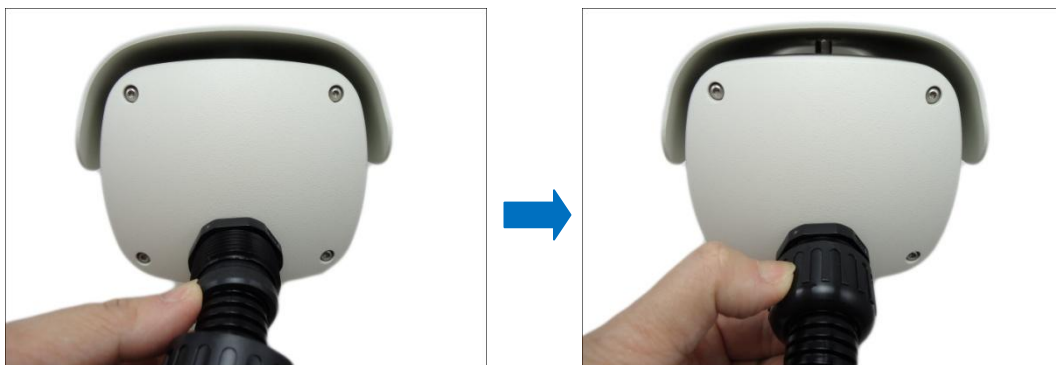

NOTE: Make sure the clamping nut is tightly attached to the cable gland body and the sealing insert is squeezed tightly.

Other Connections

This section describes the procedures in preparing the external devices that you can connect to the camera. The camera supports DC12V power input, Digital Input and Output (DI/DO) and Audio Input and Output devices using the bundled terminal blocks. The use of these devices, however, is optional.

Connecting a Power Adapter (Optional)

In case of using a non-PoE switch or your PoE switch has limited power supply, you can purchase a power adapter and directly connect the camera to a power outlet. The power adapter must be connected to the supplied terminal block before use.

To do this, follow the procedures below:

1. Loosen the screws of the **12V** and **GND** pins of the power terminal block.



2. Take note that a standard power adapter cable has two (2) different wires:

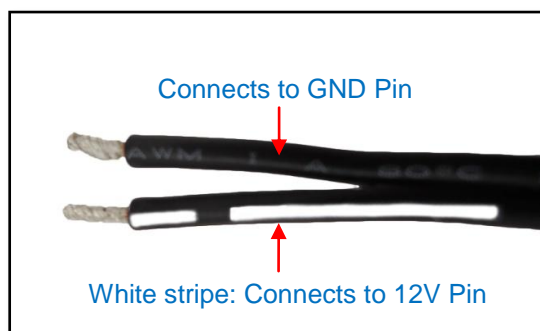

3. Connect the wire with the white stripe to the **12V** pin and the other to the **GND** pin.

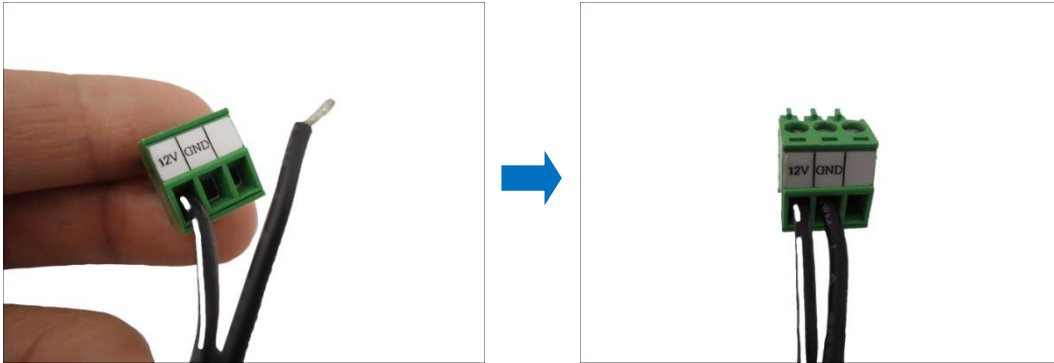

NOTE: The terminal block pictures are for reference only, note that actual label placement may vary per model.

4. Tighten the screws of the **12V** pin and the **GND** pins to secure the wire connection.



5. Set the prepared power adapter for connection later. Below is an example of a power adapter with an attached terminal block.



NOTE: The power adapter is not bundled in the package.

Connecting DI/DO and Audio Devices (Optional)

Depending on your surveillance needs, you may connect digital input / output or audio input / output devices to your camera. The camera comes with one (1) terminal block for both digital and audio input/output devices.

How to Connect DI/DO Devices

Digital Input (DI) devices can be used to notify the camera about an activity in the camera site. DI can be triggers of events. For example, you can connect a “panic button” to the camera; as such when the panic button is pressed, the alarm signal will be sent through the camera. Other common DI device applications are emergency button, smoke detector, passive infrared sensor, etc.

Digital Output (DO) devices are external devices that are activated by the camera upon an event inside the camera. For example, you can connect an “alarm horn” to the camera; as such when an event occurs inside the camera (e.g. detected intruder), the alarm horn will sound. Other common DO device applications are motion-triggered lights, electric fence, magnetic door locks, etc.

Press and hold the orange tab as you insert the wire through the pin slot, then release the orange tab to secure the wire.

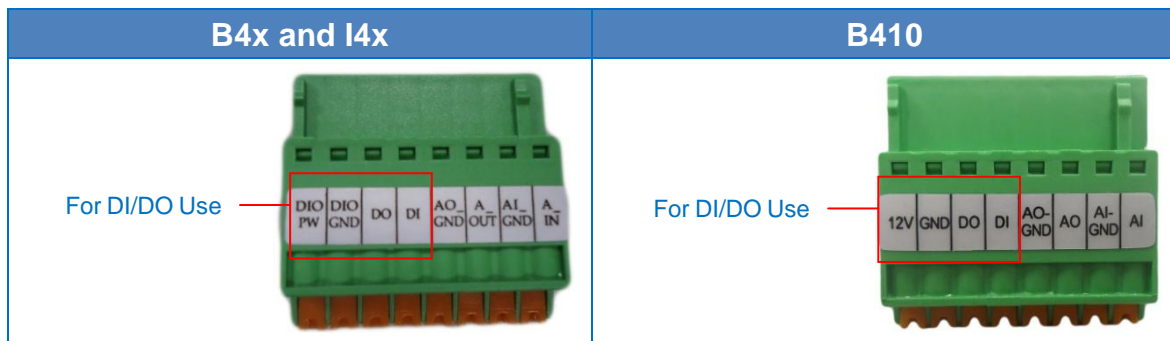

To connect digital input / output devices (DI/DO), map the pins to one of the pin combinations below:

Device	Pin	Mapping Instructions
Digital Output (DO)	DIO PW or 12V	Connect the wires of the output device to DIO PW or 12V and DO .
	DO	
Digital Input (DI)	DIO GND	Connect the wires of the input device to DIO GND and DI .
	DI	

The table below shows the DI/DO connection specifications:

Device			
DI	Connection design		TTL - compatible logic levels
	Voltage	To trigger (low)	Logic level 0: 0V ~ 0.4V
		Normal (high)	Logic level 1: 3.1V ~ 30V
	Current		10mA ~ 100mA
DO	Connection design		Transistor (Open Collector)
	Voltage & Current		< 24V DC, < 50mA

Typical Connection

Based on these specifications, if the DI device has a voltage of 0V ~ 30V or the DO device has a voltage of < 24V (< 50mA), then the camera can supply internal power to these devices and there is no need to connect the DI/DO device to an external power source.

In this case, use the **DIO GND** and **DI** pins to connect a DI device and use the **DIO PW** or **12V** and **DO** pins to connect a DO device. See wiring scheme below:

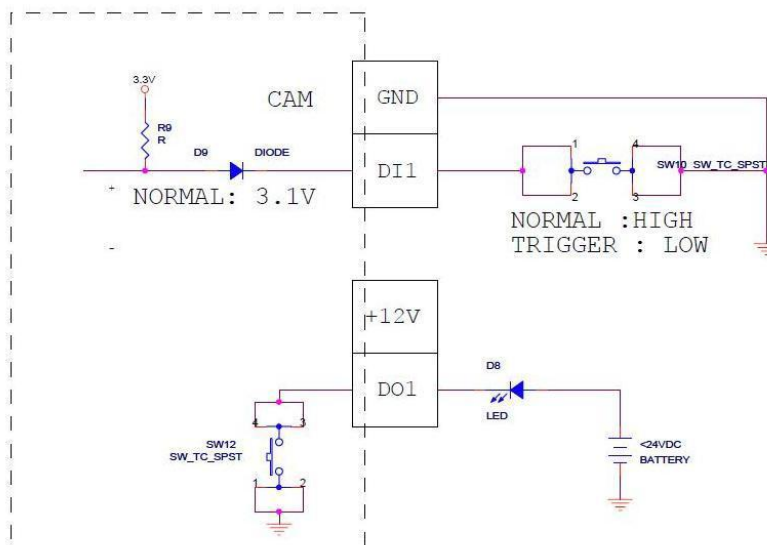

High Voltage DO Device Connection

Even though the camera provides 12V power, this may not be enough for some high voltage DO devices, such as a ceiling light or a motor that opens or closes a gate. In this case, there is a need to connect an external relay. See wiring scheme below:

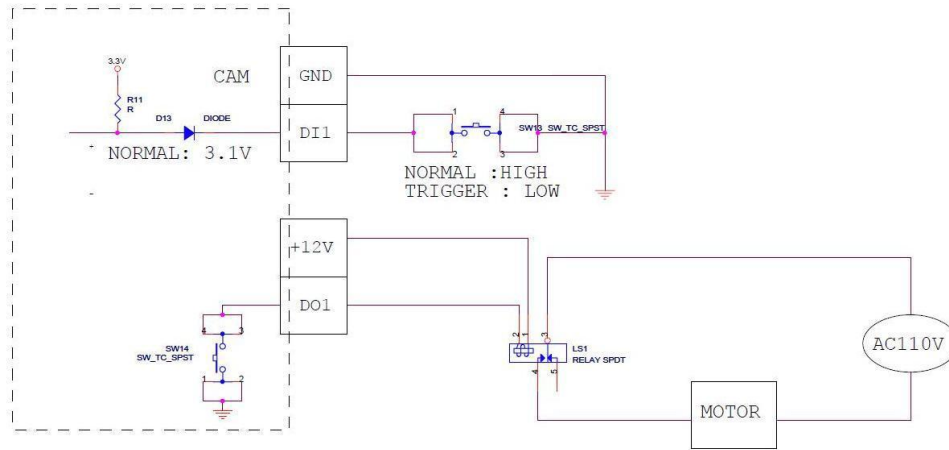

Note that when choosing an appropriate relay, please refer to its specifications and make sure they match the above design. The triggering circuit voltage has to be around 12V DC and the switch-controlled circuit voltage has to match the external power supply (e.g. 110V AC or 220V AC).

The illustration below is a graphic example of connecting a relay to a high voltage DO device.

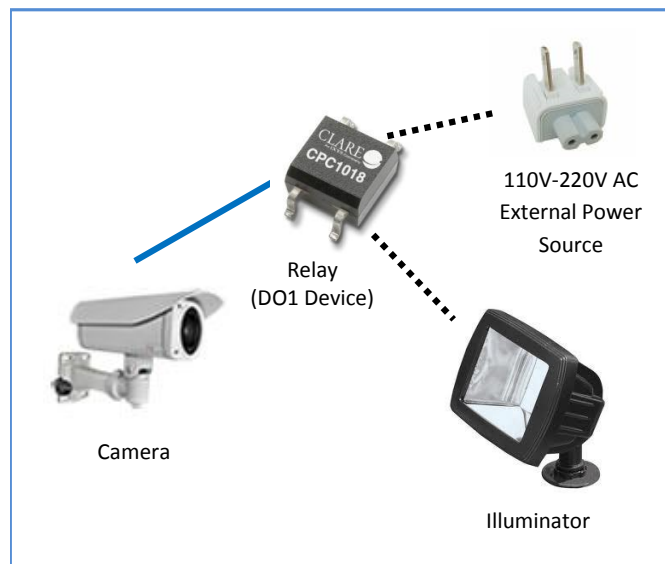

NOTE: For more information on DI/DO connections, please refer to the Knowledge Base article [All about Digital Input and Digital Output](http://www.acti.com/kb/detail.asp?KB_ID=KB20091230001) downloadable from the link below (http://www.acti.com/kb/detail.asp?KB_ID=KB20091230001).

How to Connect Audio Devices

Audio input / output devices, such as an active microphone or speaker can be connected to the camera using the supplied terminal block.

Press and hold the orange tab as you insert the wire through the pin slot, then release the orange tab to secure the wire.



To connect audio devices, map the pins to one of the pin combinations below:

Device	Pin	Mapping Instructions
Audio Output (AO)	AO_GND	Connect the wires of the audio output device to AO_GND and A_OUT or AO .
	A_OUT or AO	
Audio Input (AI)	AI_GND	Connect the wires of the audio input device to AI_GND and A_IN or AI .
	A_IN or AI	

NOTE: For more information about AUDIO in connections, please refer to the Knowledge Base article [How to Use Audio-in of ACTi Cameras](http://www.acti.com/support/KnowledgeBase/outside/detail.asp?KB_ID=KB20100114003), downloadable from the link below (http://www.acti.com/support/KnowledgeBase/outside/detail.asp?KB_ID=KB20100114003).

Other Adjustments and Accessories

How to Remove the “Pigtail”

For applications that may require the use of the Ethernet port at the back of the camera, remove the “pigtail” from the camera. Follow the procedures below:

1. Loosen the four (4) screws to remove the back cover of the camera.

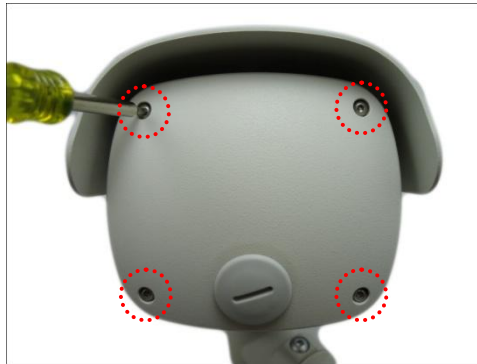

2. Disconnect the network cable from the Ethernet port and let it loose.

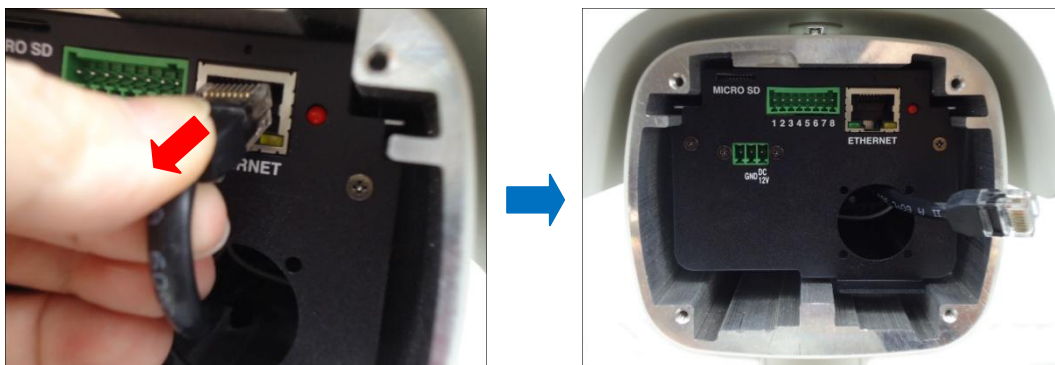

NOTE: This network cable is the other end of the “pigtail”.

- Using the bundled camera base wrench, detach the two (2) screws to remove the bracket.



- Remove the clamping nut and sealing insert.

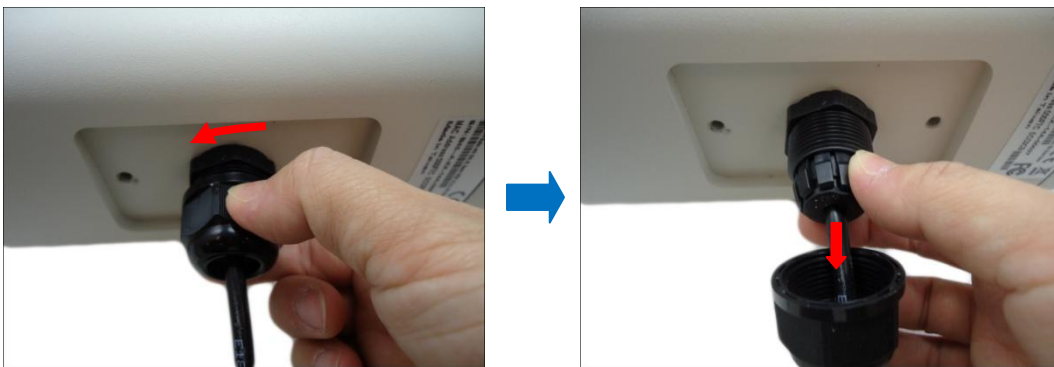

- Remove the rubber from the dome cover.

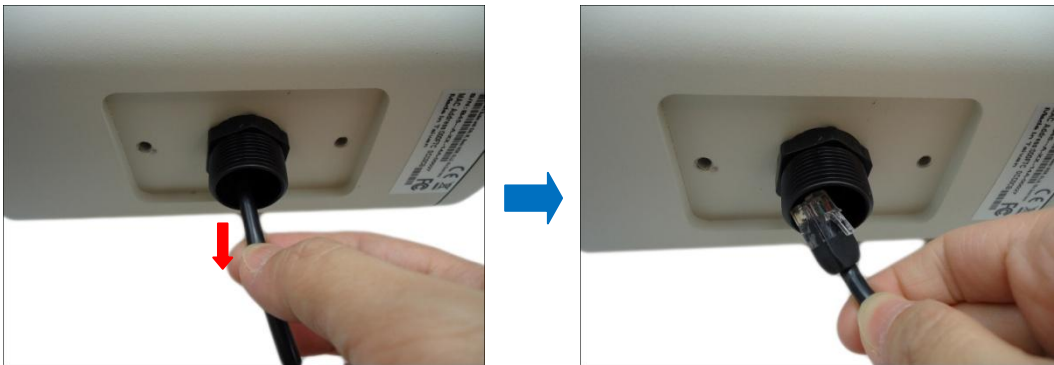

- Remove the gland body from the camera.



7. Remove the sealing insert and clamping nut from the cable, and then pull out the “pigtail” from the bracket.

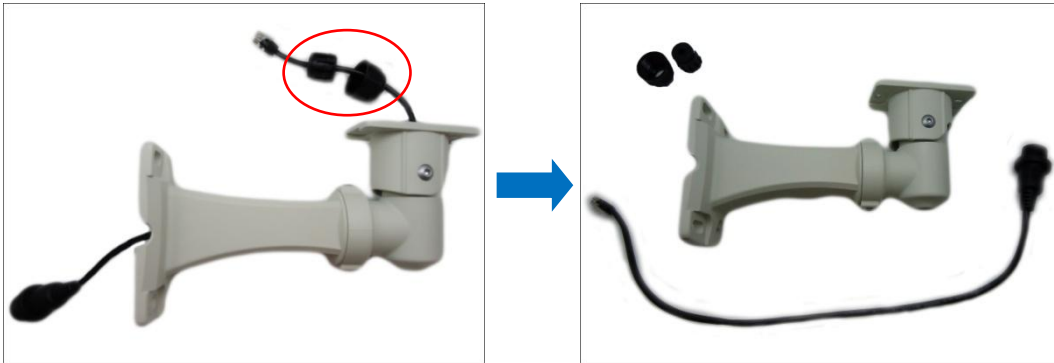

8. Using a coin or screwdriver, remove the cap from the back cover. Then attach the cap to close the cable hole.



9. Attach the bracket to the camera.



10. Attach the back cover of the camera (as needed).

How to Insert a Memory Card

The camera supports local video recording or saving of snapshots to a memory card.

NOTE: Supports microSDHC and microSDXC cards.

How to Insert the Memory Card

1. Open the back cover of the camera.
2. Insert a memory card into the card slot with the metallic contacts facing down. Push the card until it clicks into place.

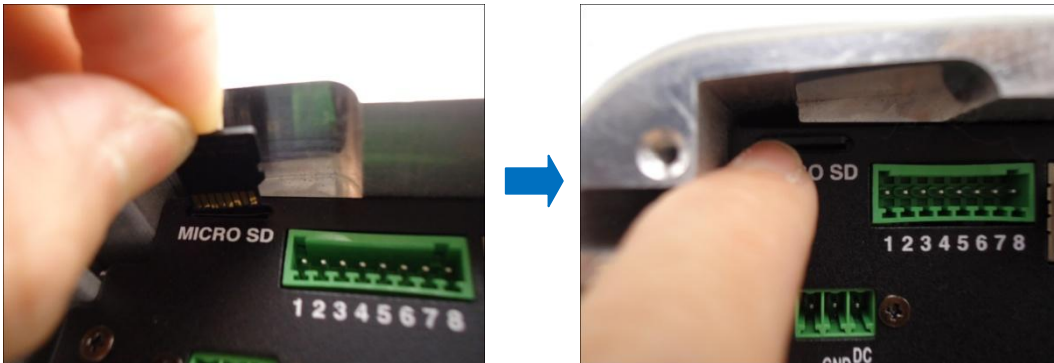

How to Remove the Memory Card

In case there is a need to remove the card, make sure to access the camera Web Configurator to safely “unmount” the card first (see the camera Firmware manual for more information). Once unmounted from the firmware, push the card to eject it from the slot.

Accessing the Camera

Configure the IP Addresses

In order to be able to communicate with the camera from your PC, both the camera and the PC have to be within the same network segment. In most cases, it means that they both should have very similar IP addresses, where only the last number of the IP address is different from each other. There are 2 different approaches to IP Address management in Local Area Networks – by DHCP Server or Manually.

Using DHCP server to assign IP addresses:

If you have connected the computer and the camera into the network that has a DHCP server running, then you do not need to configure the IP addresses at all – both the camera and the PC would request a unique IP address from DHCP server automatically. In such case, the camera will immediately be ready for the access from the PC. The user, however, might not know the IP address of the camera yet. It is necessary to know the IP address of the camera in order to be able to access it by using a Web browser.

The quickest way to discover the cameras in the network is to use the simplest network search, built in the Windows system – just by pressing the “Network” icon, all the cameras of the local area network will be discovered by Windows thanks to the UPnP function support of our cameras.

In the example below, we successfully found the camera model that had just connected to the network.

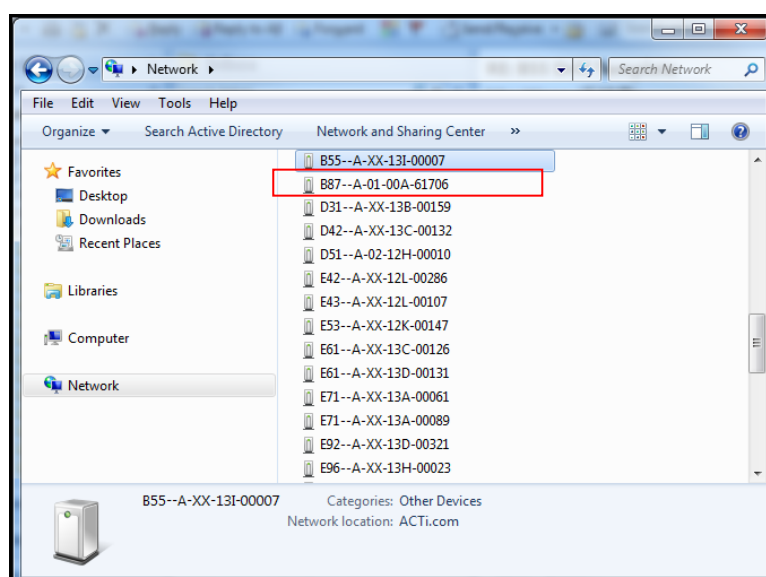

Double-click on the camera model name, the default browser of the PC is automatically launched and the IP address of the target camera is already filled in the address bar of the browser.

If you work with our cameras regularly, then **there is even a better way to discover the cameras in the network** – by using **IP Utility**. The IP Utility is a light software tool that can not only discover the cameras, but also list lots of valuable information, such as IP and MAC addresses, serial numbers, firmware versions, etc, and allows quick configuration of multiple devices at the same time.

The IP Utility can be downloaded for free from http://www.acti.com/IP_Utility

With just one click, you can launch the IP Utility and there will be an instant report as follows:

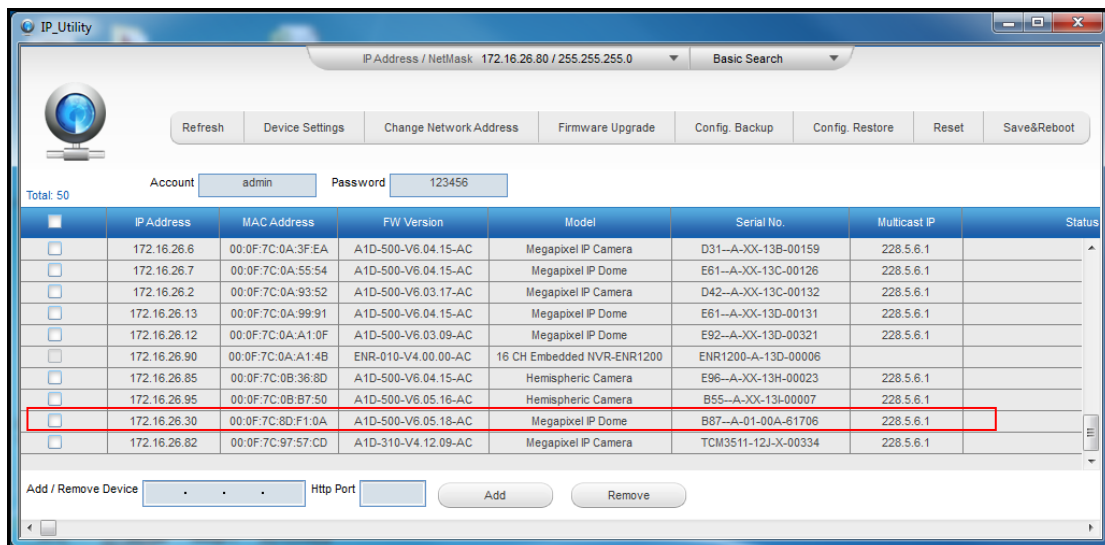

You can quickly notice the camera model in the list. Click on the IP address to automatically launch the default browser of the PC with the IP address of the target camera filled in the address bar of the browser already.

Use the default IP address of a camera:

If there is no DHCP server in the given network, the user may have to assign the IP addresses to both PC and camera manually to make sure they are in the same network segment.

When the camera is plugged into network and it does not detect any DHCP services, it will automatically assign itself a default IP:

192.168.0.100

Whereas the default port number would be **80**. In order to access that camera, the IP address of the PC has to be configured to match the network segment of the camera.

Manually adjust the IP address of the PC:

In the following example, based on Windows 7, we will configure the IP address to **192.168.0.99** and set Subnet Mask to **255.255.255.0** by using the steps below:

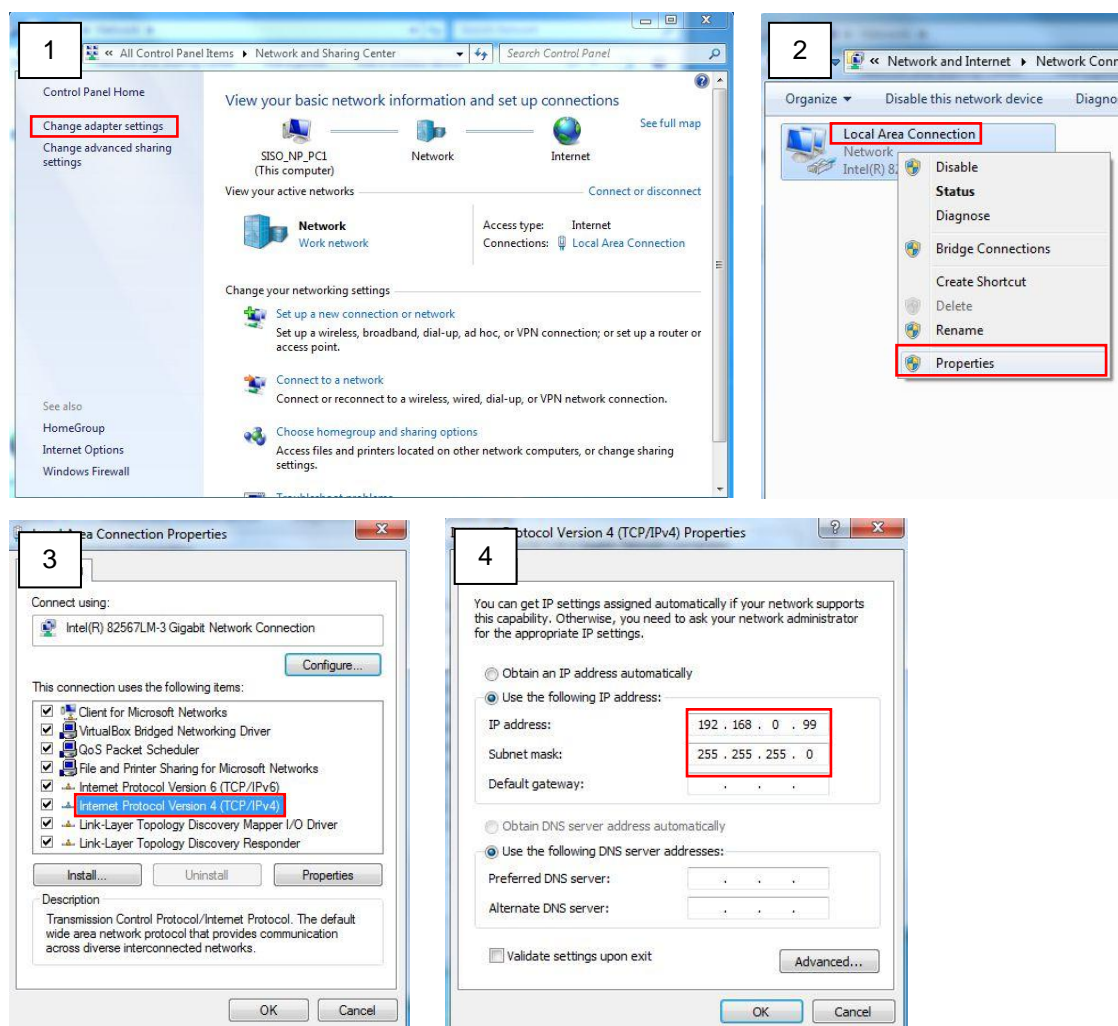

Manually adjust the IP addresses of multiple cameras:

If there are more than 1 camera to be used in the same local area network and there is no DHCP server to assign unique IP addresses to each of them, all of the cameras would then have the initial IP address of **192.168.0.100**, which is not a proper situation for network devices – all the IP addresses have to be different from each other. The easiest way to assign cameras the IP addresses is by using **IP Utility**:

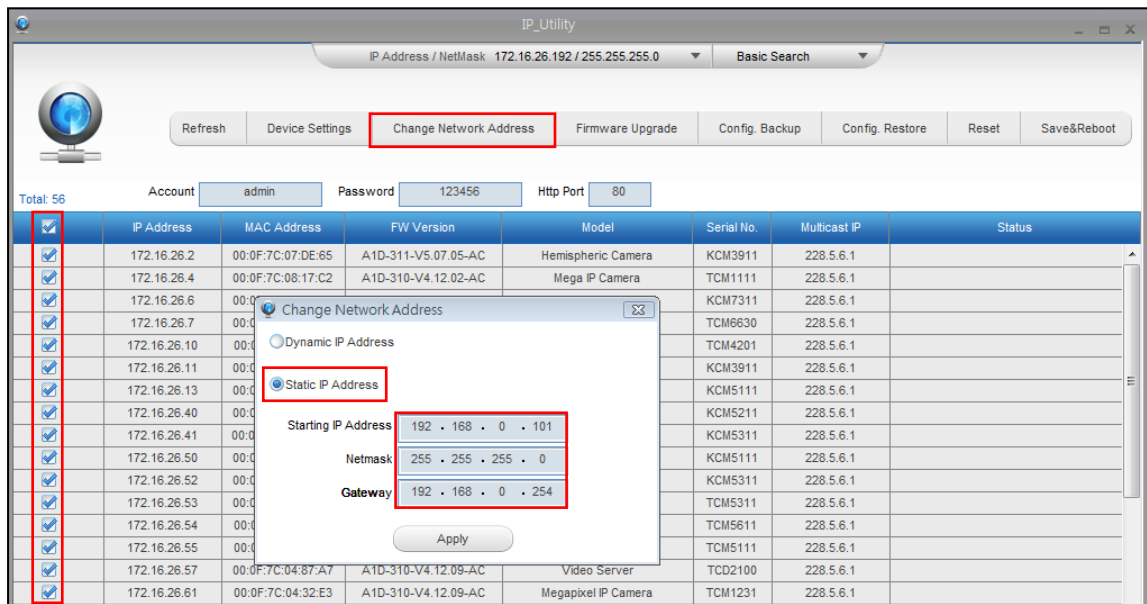

With the procedure shown above, all the cameras will have unique IP addresses, starting from 192.168.0.101. In case there are 20 cameras selected, the last one of the cameras would have the IP 192.168.0.120.

Later, by pressing the “Refresh” button of the IP Utility, you will be able to see the list of cameras with their new IP addresses.

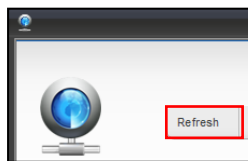

Please note that it is also possible to change the IP addresses manually by using the Web browser. In such case, please plug in only one camera at a time, and change its IP address by using the Web browser before plugging in the next one. This way, the Web browser will not be confused about two devices having the same IP address at the same time.

Access the Camera

Now that the camera and the PC are both having their unique IP addresses and are under the same network segment, it is possible to use the Web browser of the PC to access the camera.

You can use **any of the browsers** to access the camera, however, the full functionality is provided only for **Microsoft Internet Explorer**.

The browser functionality comparison:

Functionality	Internet Explorer	Other browsers
Live Video	Yes	Yes*
Live Video Area Resizable	Yes	No
PTZ Control	Yes	Yes
Capture the snapshot	Yes	Yes
Video overlay based configuration (Motion Detection regions, Privacy Mask regions)	Yes	No
All the other configurations	Yes	Yes

* When using non-Internet Explorer browsers, free third-party software plug-ins must be installed to the PC first to be able to get the live video feed from the camera:

Browser	Required Plug-In
Safari	QuickTime (http://www.apple.com/quicktime/download/)
Other non-Internet Explorer browsers	Basic VLC Media Player (http://www.videolan.org)

***Disclaimer Notice:** The camera manufacturer does not guarantee the compatibility of its cameras with VLC player or QuickTime – since these are third party softwares. The third party has the right to modify their utility any time which might affect the compatibility. In such cases, please use Internet Explorer browser instead.*

When using Internet Explorer browser, the ActiveX control for video stream management will be downloaded from the camera directly – the user just has to accept the use of such control when prompted so. No other third party utilities are required to be installed in such case.

The examples in this manual are based on Internet Explorer browser in order to cover all functions of the camera.

Assuming that the camera's IP address is **192.168.0.100**, you can access it by opening the Web browser and typing the following address into Web browser's address bar:

http://192.168.0.100

Upon successful connection to the camera, the user interface called **Web Configurator** would appear together with the login page. The HTTP port number was not added behind the IP address since the default HTTP port of the camera is 80, which can be omitted from the address for convenience.

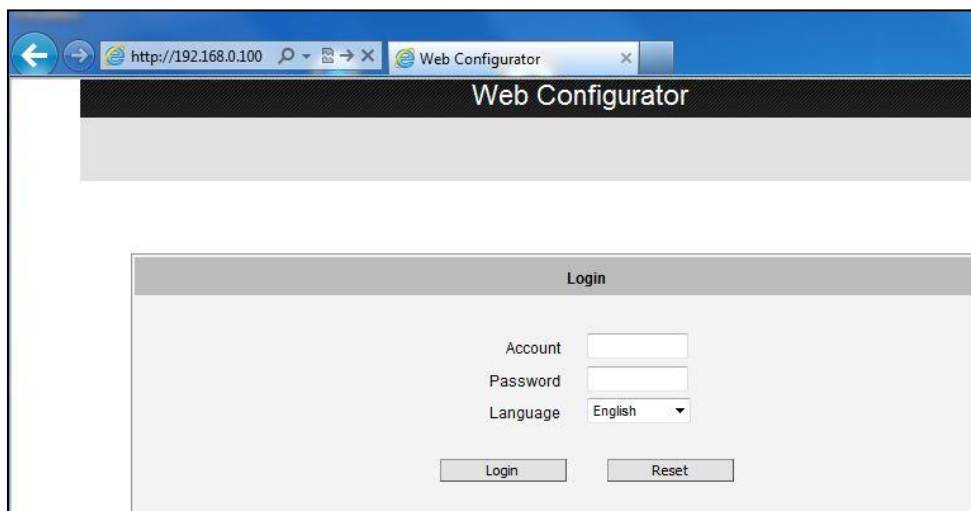

Before logging in, you need to know the factory default Account and Password of the camera.

Account: **Admin**

Password: **123456**

For further operations, please refer to the **Firmware User Manual**.



Copyright © 2014, ACTi Corporation All Rights Reserved

7F, No. 1, Alley 20, Lane 407, Sec. 2, Ti-Ding Blvd., Neihu District, Taipei, Taiwan 114, R.O.C.

TEL : +886-2-2656-2588 FAX : +886-2-2656-2599

Email: sales@acti.com