



**THE DISPLAY CHOICE  
OF PROFESSIONALS™**

**TX-2202A & TX-2202A White Touch Screen Monitor**

[www.agneovo.com](http://www.agneovo.com)

**User Manual**

# TABLE OF CONTENTS

## SAFETY INFORMATION

WEEE.....	4
-----------	---

## PRECAUTIONS

Notice .....	5
Cautions When Setting Up .....	5
Cautions When Using.....	6
Cleaning and Maintenance.....	7
Notice for the LCD Monitor .....	7

## CHAPTER 1: PRODUCT DESCRIPTION

1.1 Package Contents .....	8
1.2 Removing/Attaching Cable Cover .....	9
1.3 Adjusting the Tilt .....	10
1.4 Wall Mounting.....	11
1.5 LCD Monitor Overview .....	12
1.5.1 Front View .....	12
1.5.2 Rear View.....	12
1.5.3 Control Buttons.....	13

## CHAPTER 2: MAKING CONNECTIONS

2.1 Connecting the AC Power .....	16
2.2 Connecting Input Source Signals .....	16
2.3 Connecting Audio Device .....	17
2.4 Connecting the Wired OSD Controller .....	17
2.5 Connecting USB for Touch Screen Control .....	18
Touch Disable Function.....	18
2.6 Ventilation Requirements for Enclosure Locating.....	19

## CHAPTER 3: ON SCREEN DISPLAY MENU

3.1 Using the OSD Menu .....	20
3.2 OSD Menu Tree .....	22

## CHAPTER 4: ADJUSTING THE LCD MONITOR

4.1 Picture Menu .....	23
4.2 Colour Menu.....	25
4.3 OSD Menu.....	26
4.4 Option Menu.....	27

## CHAPTER 5: APPENDIX

5.1 Warning Messages.....	28
5.2 Timing.....	29
5.3 Touch Screen Driver Installation.....	30
5.3.1 Optional Calibration Tool Install.....	30
5.3.2 Driver Installation Instructions .....	31
5.4 Cleaning .....	32
5.5 Troubleshooting.....	33

# TABLE OF CONTENTS

## CHAPTER 6: SPECIFICATIONS

6.1 Monitor Specifications .....	34
6.2 Monitor Dimensions.....	35

# SAFETY INFORMATION

## WEEE

Disposal of Waste Equipment by Users in Private Household in the European Union.

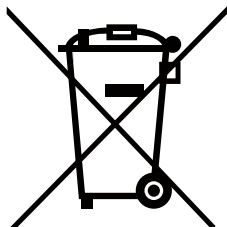

This symbol on the product or on its packaging indicates that this product must not be disposed of with your other household waste. Instead, it is your responsibility to dispose of your waste equipment by handing it over to a designated collection point for the recycling of waste electrical and electronic equipment. The separate collection and recycling of your waste equipment at the time of disposal will help to conserve natural resources and ensure that it is recycled in a manner that protects human health and the environment. For more information about where you can drop off your waste equipment for recycling, please contact your local city office, your household waste disposal service or the shop where you purchased the product.

For Private Households in the European Union. To help conserve natural resources and ensure the product is recycled in a manner that protects human health and the environment, we would like to bring your attention to the following:

- The crossed-out dustbin on the device or outer packaging indicates the product is compliant with European WEEE (Waste Electrical and Electronic Equipment) Directive
- Always dispose of the old devices separately from household waste
- Batteries should be removed beforehand and disposed separately to the right collection system
- You are responsible with regard to the deletion of personal data on old devices before disposal
- Private households can hand in their old devices free of charge
- For more information about where you can drop off your waste equipment for recycling, please contact your local city office, your household waste disposal service or the shop where you purchased the product

# PRECAUTIONS

## PRECAUTIONS

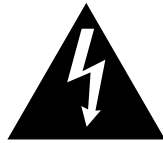

**CAUTION**  
RISK OF ELECTRIC SHOCK  
DO NOT OPEN



### Symbols used in this manual



This icon indicates the existence of a potential hazard that could result in personal injury or damage to the product.



This icon indicates important operating and servicing information.

## Notice

- Read this User Manual carefully before using the LCD monitor and keep it for future reference.
- The product specifications and other information provided in this User Manual are for reference only. All information is subject to change without notice. Updated content can be downloaded from our web site at [www.agneovo.com](http://www.agneovo.com).
- To protect your rights as a consumer, do not remove any stickers from the LCD monitor. Doing so may affect the determination of the warranty period.

## Cautions When Setting Up



Do not place the LCD monitor near heat sources, such as a heater, exhaust vent, or in direct sunlight.



Do not cover or block the ventilation holes in the housing.



Place the LCD monitor on a stable area. Do not place the LCD monitor where it may be subject to vibration or shock.



Place the LCD monitor in a well-ventilated area.



Do not place the LCD monitor outdoors.



Do not place the LCD monitor in a dusty or humid environment.



Do not spill liquid or insert sharp objects into the LCD monitor through the ventilation holes. Doing so may cause accidental fire, electric shock or damage the LCD monitor.

# PRECAUTIONS

## Cautions When Using



Use only the power cord supplied with the LCD monitor.



The power outlet should be installed near the LCD monitor and be easily accessible.



If an extension cord is used with the LCD monitor, ensure that the total current consumption plugged into the power outlet does not exceed the ampere rating.



Do not allow anything to rest on the power cord. Do not place the LCD monitor where the power cord may be stepped on.



If the LCD monitor will not be used for an indefinite period of time, unplug the power cord from the power outlet.



To disconnect the power cord, grasp and pull by the plug head. Do not tug on the cord; doing so may cause fire or electric shock.



Do not unplug or touch the power cord with wet hands.



### WARNING:

Unplug the power cord from the power outlet and refer to qualified service personnel under the following conditions:



- When the power cord is damaged.
- If the LCD monitor has been dropped or the housing has been damaged.
- If the LCD monitor emits smoke or a distinct odor.



Ceiling mount or mount on any other horizontal surface overhead are not advisable.



### WARNING:

Installation in contravention of the instructions may result in undesirable consequences, particularly hurting people and damaging property. Users who have already mounted the monitor on the ceiling or any other horizontal surface overhead are strongly advised to contact AG Neovo for consultations and solutions to help ensure a most pleasurable and fulfilling monitor experience.

# PRECAUTIONS

---

## Cleaning and Maintenance

---



Do not attempt to service the LCD monitor yourself, refer to qualified service personnel.

Opening or removing the covers may expose you to dangerous voltage or other risks.

---

---

## Notice for the LCD Monitor

---

In order to maintain the stable luminous performance, it is recommended to use low brightness setting.

Due to the lifespan of the lamp, it is normal that the brightness quality of the LCD monitor may decrease with time.

When static images are displayed for long periods of time, the image may cause an imprint on the LCD monitor. This is called image retention or burn-in.

To prevent image retention, do any of the following:

- Set the LCD monitor to turn off after a few minutes of being idle.
- Use a screen saver that has moving graphics or a blank white image.
- Switch desktop backgrounds regularly.
- Adjust the LCD monitor to low brightness settings.
- Turn off the LCD monitor when the system is not in use.

Things to do when the LCD monitor shows image retention:

- Turn off the LCD monitor for extended periods of time. It can be several hours or several days.
  - Use a screen saver and run it for extended periods of time.
  - Use a black and white image and run it for extended periods of time.
- 

There are millions of micro transistors inside the LCD monitor. It is normal for a few transistors to be damaged and to produce spots. This is acceptable and is not considered a failure.

---

# CHAPTER 1: PRODUCT DESCRIPTION

## 1.1 Package Contents

When unpacking, check if the following items are included in the package. If any of them is missing or damaged, contact your dealer.

**LCD Monitor**

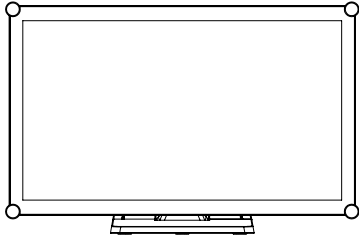

**Quick Start Guide**



**Warranty Card**

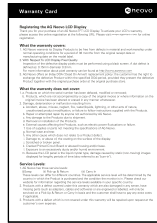

**Cable Cover and Screw**

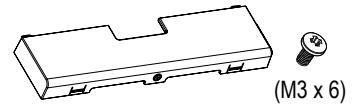

**Power Adaptor(\*)**

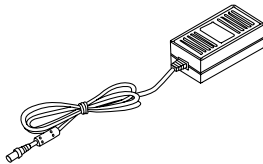

**Power Cord**

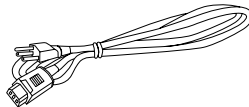

**HDMI Cable**

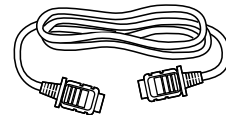

**VGA Cable**

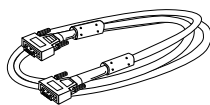

**USB Cable**

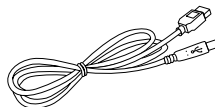

**Audio Cable**

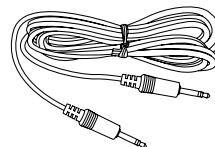

**Note: (\*)**

- Use only the supplied power cord.
- The above pictures are for reference only. Actual items may vary upon shipment.
- (\*) Must use only the supplied power adapter:
  - Vendor: Delta/ SOY/ ADAPTER
  - Model no.: ADP-50YH B/ SOY-1200500-327/ ATM065T-P120
  - Rating: 12V 4.16A/12V 4.16A/12V 5.0A



# PRODUCT DESCRIPTION

## 1.2 Removing/Attaching Cable Cover

1. Lay the LCD monitor face down on a flat even surface.
2. Press on the cable cover latches and then remove the cable cover as shown in the illustration below.

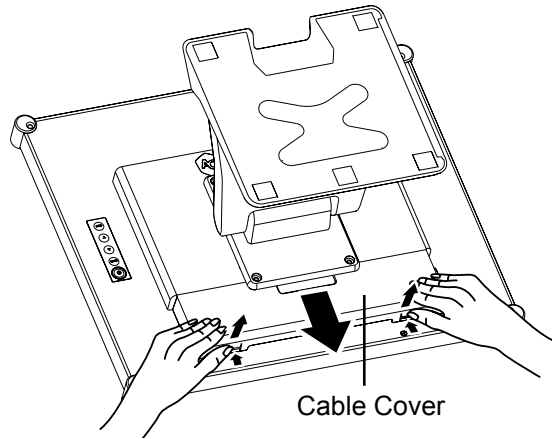

3. After connect the cables to the appropriate connectors and position all cables under the cover lip, attach the cable cover. Take the screw (M3 x 6) from the accessory box, and insert the screw into the cable cover and monitor

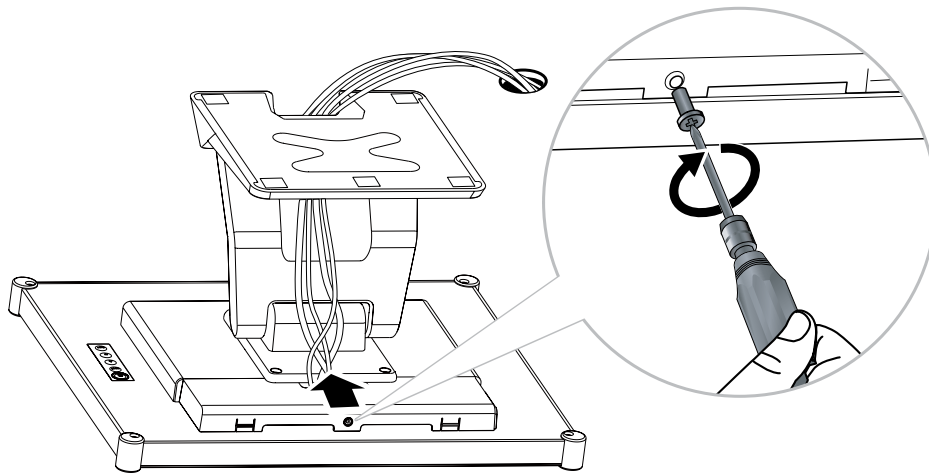

# PRODUCT DESCRIPTION

## 1.3 Adjusting the Tilt

For comfort viewing, tilt the LCD monitor up to an angle of  $-5^{\circ}$  to  $90^{\circ}$ . Hold the stand with one hand and use the other to adjust the LCD monitor to the desired angle.

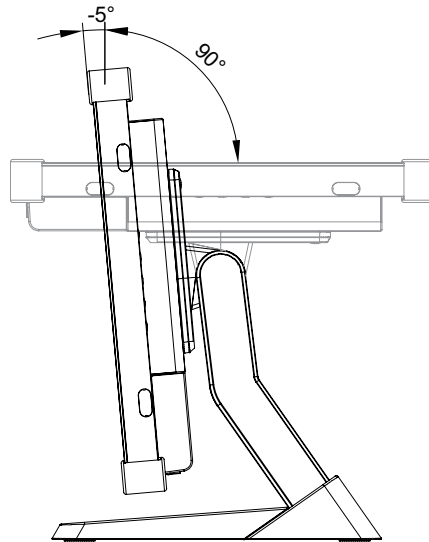

# PRODUCT DESCRIPTION

## 1.4 Wall Mounting

To wall-mount the LCD monitor, screw the mounting bracket to the VESA holes at the rear of the LCD monitor.

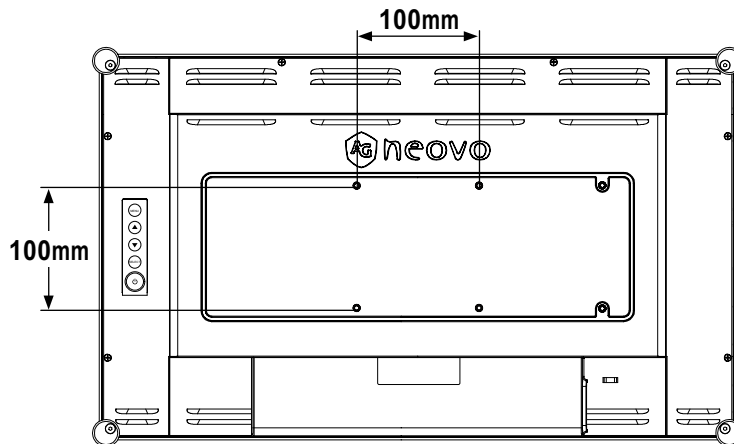

**Note:** Take measures to prevent the LCD monitor from falling down and lessen possible injury and damage to the monitor in case of earthquakes or other disasters.

- Use only the 100 x 100 mm wall mount kit recommended by AG Neovo. All AG Neovo wall mount kits comply with VESA standard.
- Secure the LCD monitor on a solid wall strong enough to bear its weight.
- It is suggested to wall mount the LCD monitor without tilting it facing downward.
- For TX-2202A, the distance between the back cover surface and the bottom of the screw hole is 7 mm. Please use four M4 screws diameter with proper length to mount your monitor. The mounting stand must be able to support at least 6.7 kg (14.8 lb).

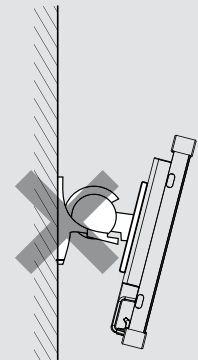

# PRODUCT DESCRIPTION

## 1.5 LCD Monitor Overview

### 1.5.1 Front View

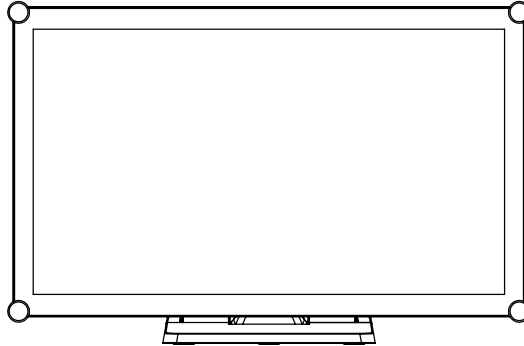

### 1.5.2 Rear View

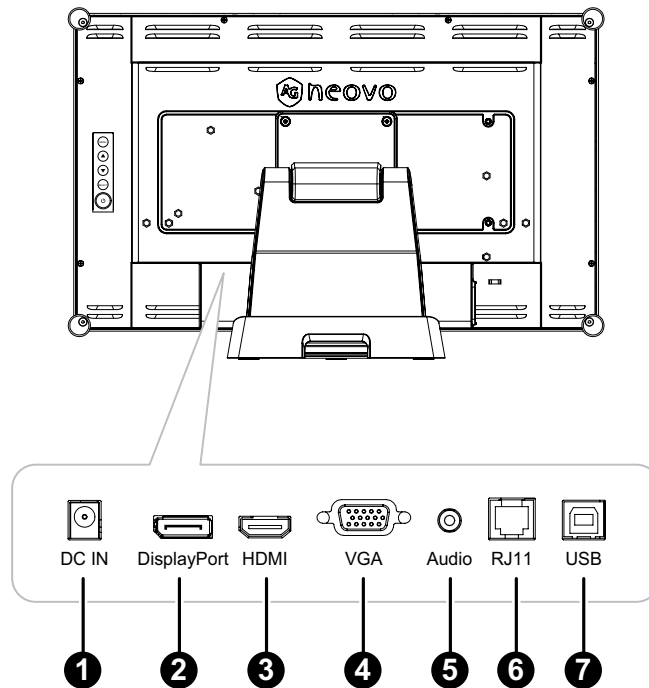

- 1 DC IN:**  
Connect with the supplied power adaptor.
- 2 DisplayPort:**  
Connect DisplayPort signals input.
- 3 HDMI:**  
Connect HDMI signals input.
- 4 VGA:**  
Connect VGA signals input.

# PRODUCT DESCRIPTION

- 5 **AUDIO IN:**  
Connect to audio input source (3.5 mm Stereo Audio Jack).
- 6 **RJ11:**  
Connect with wired OSD control. (Don't connect telephone or internet cable to RJ-Type port.)
- 7 **USB:**  
Connect USB for touch screen control.

## 1.5.3 Control Buttons

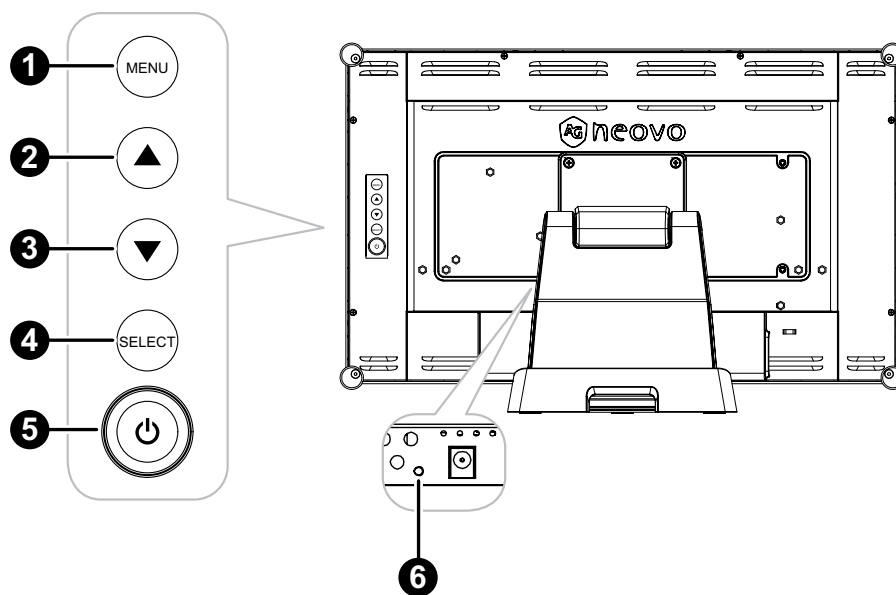

- 1 **MENU:**
  - OSD menu ON/OFF and return to main item.
- 2 **UP (▲): Hot Key: Brightness**
  - When OSD menu is ON, navigate through adjustment icons or adjust a function.
  - When the UP key is pressed, the brightness can be adjusted. The UP/DOWN key can be used for brightness adjustment.

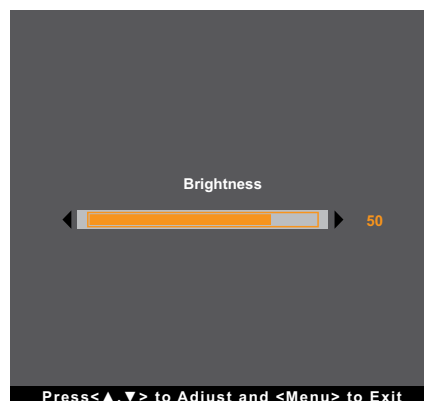

# PRODUCT DESCRIPTION

## 3 DOWN (▼): Hot Key: Mute

- When OSD menu is ON, navigate through adjustment icons or adjust a function.
- When the DOWN key is pressed, switch the audio mute ON/OFF.



## 4 SELECT:

- When OSD menu is ON, the key is used for function adjustment confirmation.
- When selecting the input source:
  - If the monitor is in ON mode, press the SELECT key for 3 seconds to turn on the “Source Select” menu.
  - If the monitor is in Standby mode, press the SELECT key for 1 second to turn on the “Source Select” menu.

**Note:** For detailed adjustment of “Source Select”, please refer to page 27.

## 5 POWER (⏻):

- Press to turn the monitor ON or OFF.

## 6 Power Indicator:

Indicate the operating status of the LCD monitor:

- Lights Green when the LCD monitor is turned on.
- Lights Amber when the LCD monitor is in standby mode.
- Lights Off when the LCD monitor is turned off.

# PRODUCT DESCRIPTION

**Note:** To lock/unlock the MENU key and/or the  key, press the MENU and ▼ keys simultaneously. Then select the desired lock/unlock function.

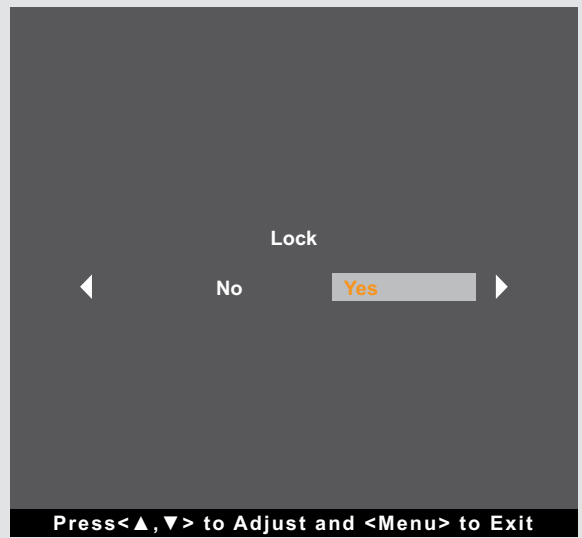
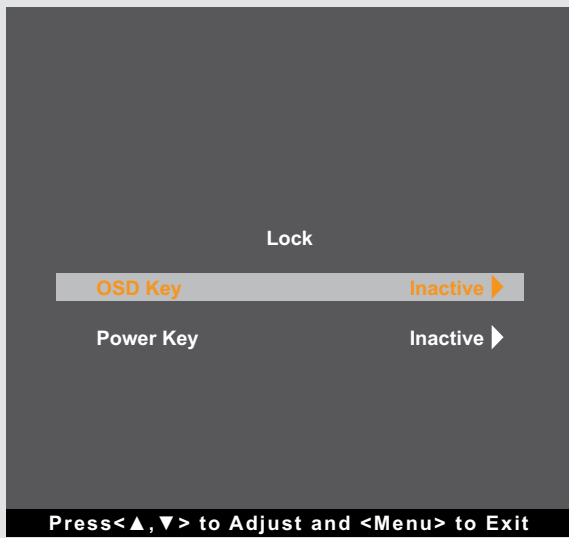

# CHAPTER 2: MAKING CONNECTIONS



## CAUTION:

Make sure that the LCD monitor is not connected to the power outlet before making any connections. Connecting cables while the power is ON may cause possible electric shock or personal injury.

## 2.1 Connecting the AC Power

1. Connect the power cord to the power adapter.
2. Connect the power adapter to the DC power input at the rear of the LCD monitor.
3. Connect the power cord plug to a power outlet or a power supply.

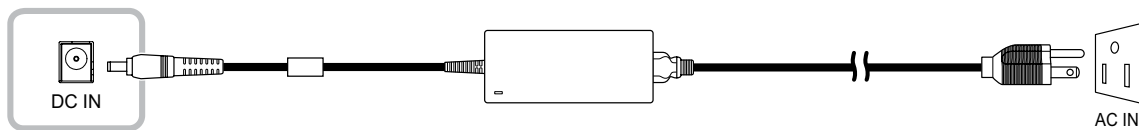

## CAUTION:

When unplugging the power cord, hold the power cord by the plug head. Never pull by the cord.

## 2.2 Connecting Input Source Signals

Input source signals can be connected with either of the following cables:

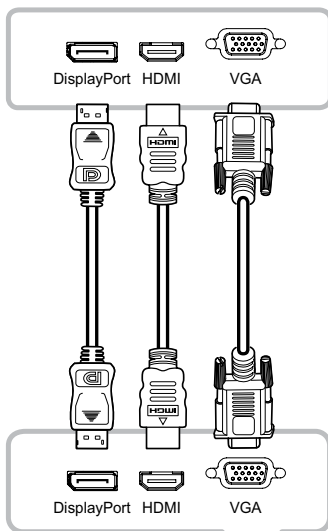

- **DisplayPort**

Connect one end of a DP cable to the DisplayPort connector of the LCD monitor and the other end to the DisplayPort connector of the computer.

- **HDMI**

Connect one end of an HDMI cable to the HDMI connector of the LCD monitor and the other end to the HDMI connector of the computer.

- **VGA**

Connect one end of a D-Sub (VGA) cable to the D-Sub (VGA) connector of the LCD monitor and the other end to the D-Sub (VGA) connector of the computer.

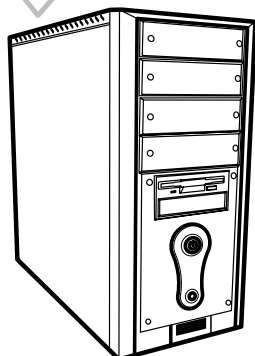

**Note:** To ensure the LCD monitor works well with your computer, please configure the display mode of your graphics card to make it less than or equal to 1920 x 1080 resolution and make sure the timing of the display mode is compatible with the LCD monitor. For compatible Video Modes of your LCD monitor, please refer to “5.2 Timing” on page 29.



# MAKING CONNECTIONS

## 2.3 Connecting Audio Devices

Connect one end of an audio cable to the AUDIO IN connector of the LCD monitor and the other end to the AUDIO OUT connector of the computer.

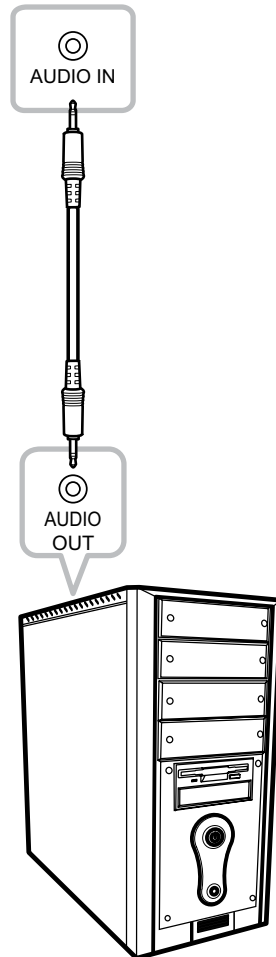

## 2.4 Connecting the Wired OSD Controller

Connect the wired OSD controller (optional, not supplied) to the RJ11 connector of the LCD monitor.

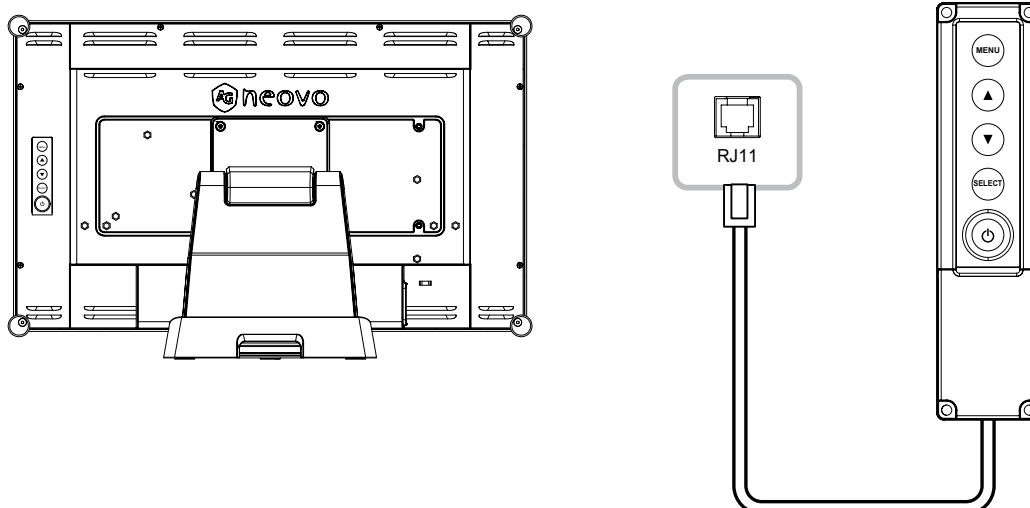

# MAKING CONNECTIONS

## 2.5 Connecting USB for Touch Screen Control

Connect one end of a USB cable to the USB connector of the LCD monitor and the other end to the USB connector of the computer.

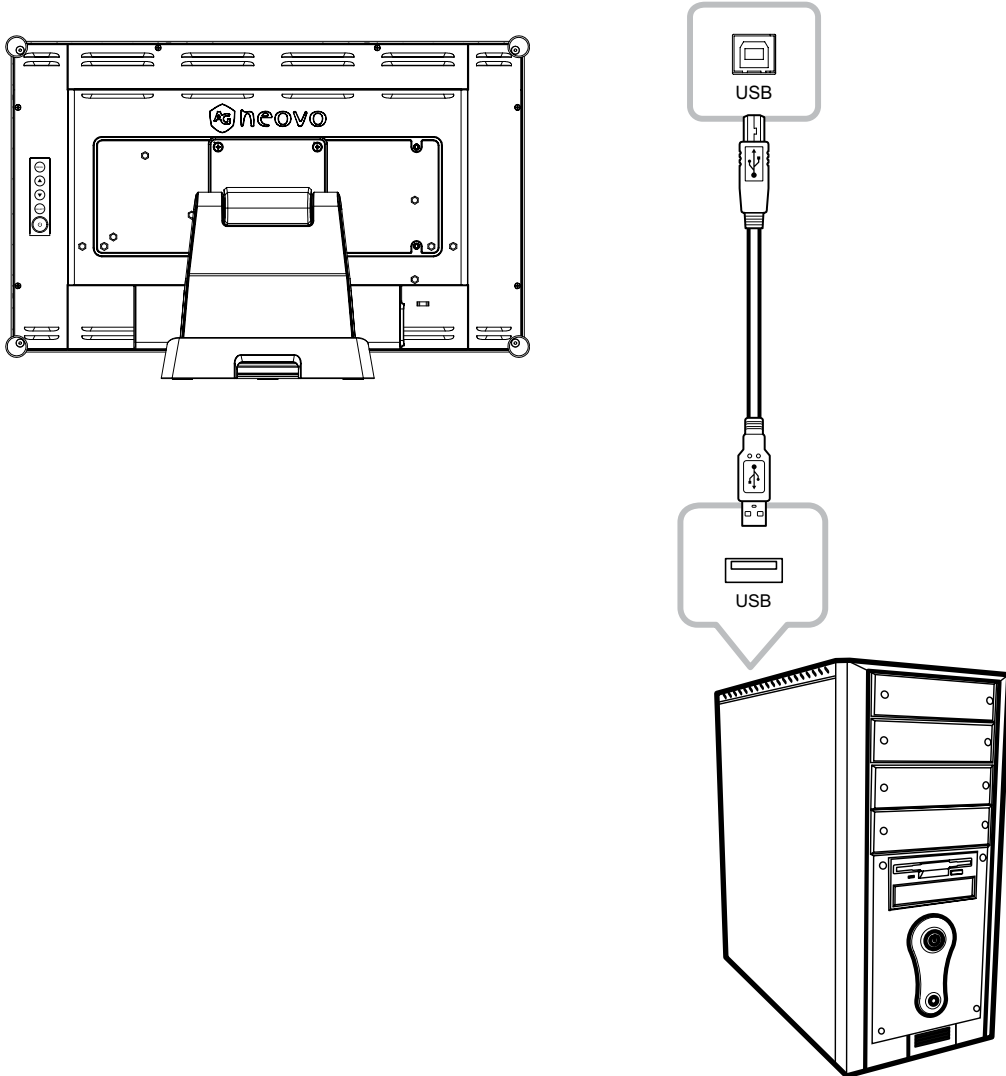

### Touch Disable Function

To disable the touch function, do the following:

1. Press “Menu” and “Select” keys simultaneously. The “Touch disable” message appears on the screen.

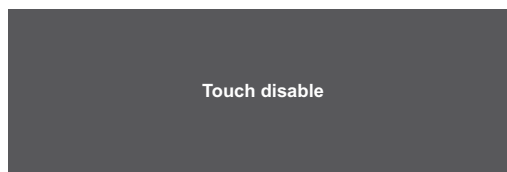

2. To enable the touch function, press “Menu” and “Select” keys simultaneously for five seconds.

# MAKING CONNECTIONS

## 2.6 Ventilation Requirements for Enclosure Locating

To allow heat to disperse, avoid installing the LCD monitor directly on the cabinet wall and make sure the operating/storage temperature/humidity requirements are met as described below:

- Operating conditions: 0°C-40°C (32°F-104°F)
- Operating humidity (non-condensing): 20%-80%
- Operating altitude: < 10,000 feet (3,048m)
- Storage conditions: -20°C-60°C (-4°F-140°F)
- Storage humidity (non-condensing): 10%-90%

# CHAPTER 3: ON SCREEN DISPLAY MENU

## 3.1 Using the OSD Menu

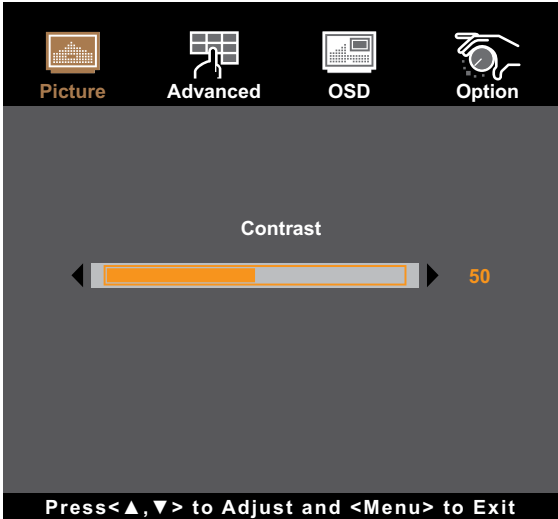
#	Menu Navigation	Operation
1	<p>Display the main menu screen.</p> 	<p>Press MENU.</p>
2	<p>Enter the submenu.</p>  <p>The active main menu and submenu icon is highlighted in orange.</p>	<ol style="list-style-type: none"> <li>1 Press ▲/▼ to select the main menu item.</li> <li>2 Press SELECT to enter the submenu.</li> <li>3 Press ▲/▼ to select the submenu item.</li> <li>4 Press SELECT to enter the selected submenu.</li> </ol>

# ON SCREEN DISPLAY MENU

#	Menu Navigation	Operation
<b>3</b>	Adjust the settings or select the value. For example:  <p>The screenshot shows the OSD menu with four tabs: Picture, Advanced, OSD, and Option. The 'Advanced' tab is selected. The main menu displays 'Auto Adjust' with 'No' highlighted in orange. Navigation arrows are visible on the left and right. A footer bar at the bottom reads 'Press &lt;▲, ▼&gt; to Adjust and &lt;Menu&gt; to Exit'.</p>	<ol style="list-style-type: none"> <li>1 Press ▲/▼ to adjust the value or select the setting.</li> <li>2 Press SELECT to confirm the setting (if necessary).</li> </ol>
<b>4</b>	Return to the previous menu and/or close the OSD window.	Press MENU once to return to the previous menu. Press MENU repeatedly (if necessary) to close the OSD window.

**Note:** When settings are modified, all changes are saved when the user does the following:

- Proceeds to another menu
- Exits the OSD menu
- Waits for the OSD menu to disappear

# ON SCREEN DISPLAY MENU

## 3.2 OSD Menu Tree

Main Menu	Submenu	Reference
Picture	Contrast	Refer to page 23.
	Brightness	
	H-Position	
	V-Position	
	Phase	
	Clock	
	Auto Adjust	
Advanced	Color Temp	Refer to page 25.
	USER	
	Picture Mode	
	Sharpness	
OSD	OSD Timeout	Refer to page 26.
	OSD Position	
	OSD H-Position	
	OSD V-Position	
	Touch Switch	
Option	Reset	Refer to page 27.
	Language	
	Source Select	
	DisplayMode	
	Volume	
	Mute	
	Factory	

**Note:** Availability of some menu items depend on the input source signal. If the menu is not available, it is disabled and greyed out.

# CHAPTER 4: ADJUSTING THE LCD MONITOR

## 4.1 Picture Menu

1. Press MENU on the control panel to call out the OSD window.
2. Press ▲/▼ to select Picture and then press SELECT to enter the menu.
3. Press ▲/▼ to select the submenu item and then press SELECT to enter its settings.

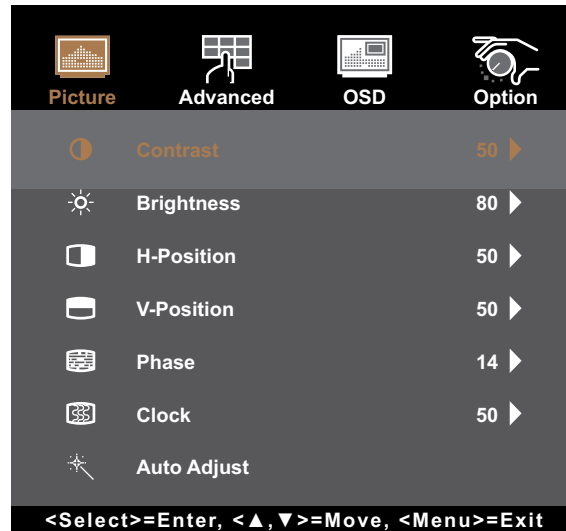

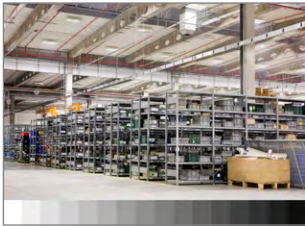
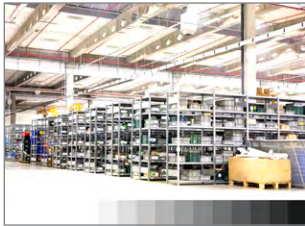
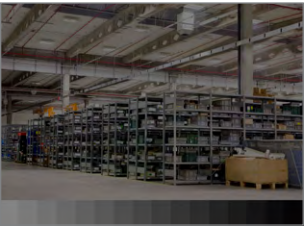
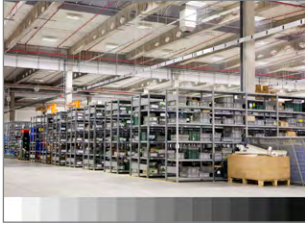
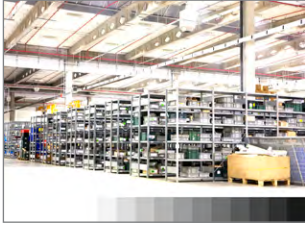
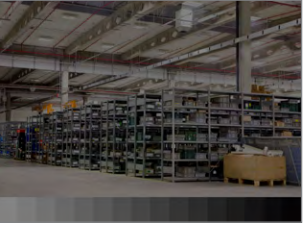
Item	Function	Operation	Range
Contrast	Adjusts the difference between the black level and the white level.	Press ▲/▼ to adjust the value.	0 to 100
	<div style="display: flex; justify-content: space-around;"> <div style="text-align: center;"> <p><i>Original Setting</i></p>  </div> <div style="text-align: center;"> <p><i>High Setting</i></p>  </div> <div style="text-align: center;"> <p><i>Low Setting</i></p>  </div> </div>		
Brightness	Adjusts the luminance of the screen image.	Press ▲/▼ to adjust the value.	0 to 100
	<div style="display: flex; justify-content: space-around;"> <div style="text-align: center;"> <p><i>Original Setting</i></p>  </div> <div style="text-align: center;"> <p><i>High Setting</i></p>  </div> <div style="text-align: center;"> <p><i>Low Setting</i></p>  </div> </div>		
H-Position (Horizontal Position)	Moves the screen image to the left or to the right.	Press ▲/▼ to adjust the value.	0 to 100
	<div style="border: 1px solid gray; padding: 5px; background-color: #f0f0f0;"> <p><b>Note:</b> This menu item is only available if the source is VGA.</p> </div>		

# ADJUSTING THE LCD MONITOR

Item	Function	Operation	Range
V-Position (Vertical Position)	Moves the screen image up or down. <b>Note:</b> <i>This menu item is only available if the source is VGA.</i>	Press ▲/▼ to adjust the value.	0 to 100
Phase	Adjusts the phase timing to synchronise with the video signal. <b>Note:</b> <i>This menu item is only available if the source is VGA.</i>	Press ▲/▼ to adjust the value.	0 to 100
Clock	Adjusts the frequency timing to synchronise with the video signal. <b>Note:</b> <i>This menu item is only available if the source is VGA.</i>	Press ▲/▼ to adjust the value.	0 to 100
Auto Adjust	Automatically optimises image display.  <b>Note:</b> <i>This menu item is only available if the source is VGA.</i>	Press ▲/▼ to select the setting and then press SELECT to confirm.	No Yes



# ADJUSTING THE LCD MONITOR

## 4.2 Advanced Menu

1. Press MENU on the control panel to call out the OSD window.
2. Press ▲/▼ to select Colour and then press SELECT to enter the menu.
3. Press ▲/▼ to select the submenu item and then press SELECT to enter its settings.

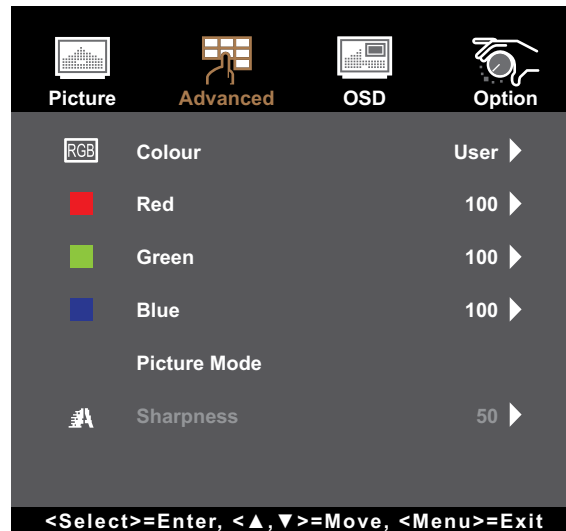

Item	Function	Operation	Range
Colour	Provides several colour adjustment settings.	Press ▲/▼ to select the setting and then press SELECT to confirm.	5500K 6500K 7500K 9300K User
	Colour temperature can be set to: <ul style="list-style-type: none"> <li>• <b>5500K</b>: Applies a reddish tint for warmer colours.</li> <li>• <b>6500K</b>: This is the default colour temperature commonly used for normal lighting conditions.</li> <li>• <b>7500K</b>: Applies the screen colour between red and blue.</li> <li>• <b>9300K</b>: Applies a bluish tint for cooler colours.</li> <li>• <b>User</b>: This allows users to set the colour temperature by adjusting the Red, Green, and Blue value according to one's preference.</li> </ul>		
Sharpness	Adjusts the clarity and focus of the screen image. <div style="border: 1px solid gray; padding: 5px; margin-top: 10px;"> <p><b>Note:</b> The Sharpness function is not supported with the following resolutions:</p> <ul style="list-style-type: none"> <li>• 1920x1080</li> </ul> </div>	Press ▲/▼ to adjust the value.	0 to 100

# ADJUSTING THE LCD MONITOR

## 4.3 OSD Menu

1. Press **MENU** on the control panel to call out the OSD window.
2. Press **▲/▼** to select **OSD** and then press **SELECT** to enter the menu.
3. Press **▲/▼** to select the submenu item and then press **SELECT** to enter its settings.

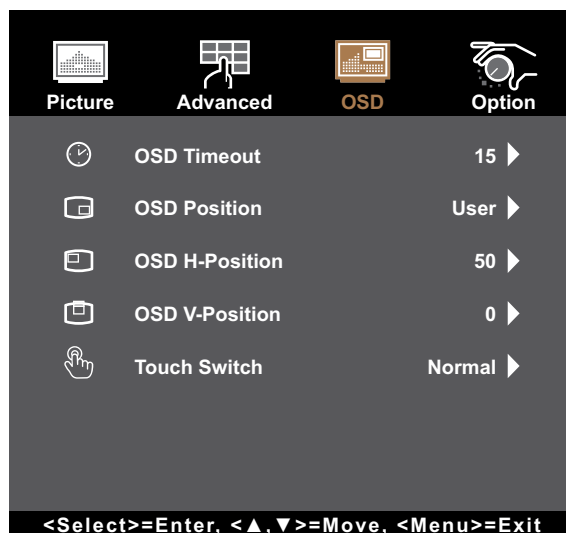

Item	Function	Operation	Range
OSD Timeout	Sets the length of time (in seconds) the OSD screen is displayed. When the time elapses, the OSD screen is automatically inactivated.	Press <b>▲/▼</b> to adjust the value.	5 to 60
OSD Position	Sets the OSD window location on the screen.	Press <b>▲/▼</b> to select the setting and then press <b>SELECT</b> to confirm.	User-defined
OSD H-Position (Horizontal Position)	Moves the OSD window to the left or right of the screen.	Press <b>▲/▼</b> to adjust the value.	0 to 100
OSD V-Position (Vertical Position)	Moves the OSD window up or down the screen.	Press <b>▲/▼</b> to adjust the value.	0 to 100
Touch Switch	<p>Sets the touch setting.</p> <ul style="list-style-type: none"> <li>• <b>Normal:</b> Supports 10-point multi-touch. Touch the screen with bare fingers or stylus.</li> <li>• <b>Glove:</b> Supports 5-point multi-touch. Touch the screen with gloves on.</li> <li>• <b>Through-Glass:</b> Touch the screen through the glass. Supports 2-point multi-touch and maximum cover glass thickness ≤ 6 mm.</li> </ul> <p><b>Note:</b> After setting the Touch Switch setting, exit the OSD menu and restart the LCD display.</p>	Press <b>▲/▼</b> to select the setting and then press <b>SELECT</b> to confirm.	Normal Glove Through-Glass

# ADJUSTING THE LCD MONITOR

## 4.4 Option Menu

1. Press MENU on the control panel to call out the OSD window.
2. Press ▲/▼ to select System and then press SELECT to enter the menu.
3. Press ▲/▼ to select the submenu item and then press SELECT to enter its settings.

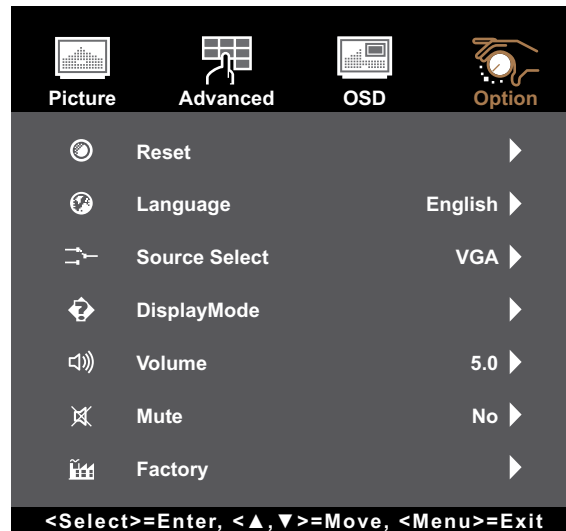



Item	Function	Operation	Range
Reset	Resets the device to the factory default settings.	Press ▲/▼ to select the setting and then press SELECT to confirm.	No Yes
Language	Selects the language used for OSD menus.	Press ▲/▼ to select the setting and then press SELECT to confirm.	English Français Deutsch Italiano Español 日本語 繁中 簡中
Source Select	Sets the input source.  <b>Note:</b> <i>If the source is set to "Auto" then the monitor detects the input source automatically.</i>	Press ▲/▼ to select the setting and then press SELECT to confirm.	Auto VGA HDMI DP
DisplayMode	View the source, resolution, and frequency.	Press MENU to return to the System menu.	N/A
Volume	Adjusts the volume level of the built-in speaker.	Press ▲/▼ to adjust the value.	0 to 100
Mute	Turns the audio ON or OFF.	Press ▲/▼ to select the setting and then press SELECT to confirm.	No Yes
Factory	This is maintenance function for service main. Do not operate this function.	N/A	N/A

# APPENDIX

## 5.1 Warning Messages

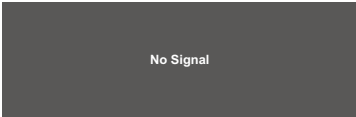
When any of these warning messages appear, check the following items.

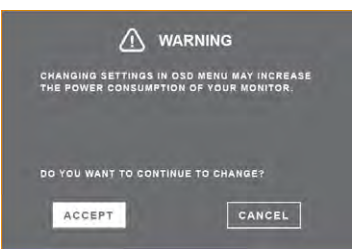
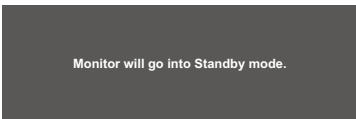
Warning Message	Cause	Solution
 <p>No Signal</p>	<p>The LCD monitor cannot detect the input source signal.</p>	<ul style="list-style-type: none"> <li>√ Check if the input source is turned ON.</li> <li>√ Check if the signal cable is properly connected.</li> <li>√ Check if any pin inside the cable connector is twisted or broken.</li> </ul>
 <p>Out of Range</p>	<p>The resolution or the refresh rate of the graphics card of the computer is set too high.</p> <div style="border: 1px solid gray; padding: 5px; margin-top: 10px;"> <p><b>Note:</b> <i>If you see the “Out of Range” message on the screen, then the OSD menu cannot be operated.</i></p> </div>	<ul style="list-style-type: none"> <li>√ Change the resolution or the refresh rate of the graphics card.</li> </ul>
 <p>WARNING CHANGING SETTINGS IN OSD MENU MAY INCREASE THE POWER CONSUMPTION OF YOUR MONITOR. DO YOU WANT TO CONTINUE TO CHANGE? ACCEPT CANCEL</p>	<p>Increasing the brightness and/or contrast may increase the power consumption of the monitor.</p>	<ul style="list-style-type: none"> <li>√ Select “ACCEPT” to confirm or “CANCEL” to cancel the modifications.</li> </ul>
 <p>Monitor will go into Standby mode.</p>	<p>The LCD monitor is in Standby mode. The LCD monitor will enter Standby mode when experiencing a sudden signal disconnecting problem.</p>	<ul style="list-style-type: none"> <li>√ Check if the signal cable is properly connected.</li> <li>√ The monitor can be activated by pressing any keyboard, triggering the mouse, or touching the screen.</li> <li>√ Check if the correct source is selected in the OSD &gt; System &gt; Source select menu. Refer to page 31.</li> </ul>

# APPENDIX

## 5.2 Timing

Mode	Resolution	H-Frequency(khz)	V-Frequency(hz)
IBM VGA	720 x 400	31.47	70
IBM VGA	640 x 480	31.47	60
Apple MacII	640 x 480	35.00	66
VESA VGA	640 x 480	37.86	72
VESA VGA	640 x 480	37.50	75
VESA SVGA	800 x 600	35.16	56
VESA SVGA	800 x 600	37.88	60
VESA SVGA	800 x 600	48.08	72
VESA SVGA	800 x 600	46.88	75
Apple Mac	832 x 624	49.72	75
VESA XGA	1024 x 768	48.36	60
VESA XGA	1024 x 768	56.48	70
VESA XGA	1024 x 768	60.02	75
VESA SXGA	1280 x 1024	64.00	60
VESA SXGA	1280 x 1024	80.00	75
VESA SXGA	1152 x 864	67.50	75
VESA SXGA	1280 x 960	60.00	60
WXGA+	1440 x 900	56.00	60
WXGA+	1440 x 900	70.60	75
WSXGA+	1680 x 1050	65.29	60
WSXGA+	1680 x 1050 (VGA only)	82.30	75
VESA WXGA	1280 x 768	47.77	60
WSXGA+	1920 x 1080	67.50	60

# APPENDIX

## 5.3 Touch Screen Driver Installation

The LCD monitor is available with USB connections. The touch driver can be downloaded from [211.72.159.212/AP/Service/TPDriver.nsf/](http://211.72.159.212/AP/Service/TPDriver.nsf/) website. Documents and drivers password: Ili888

The supported operating systems are Windows® 7/8/10/11, Windows VISTA/XP/2000/CE/XP Embedded, Mac OS 10.10-10.14, Linux 2.6.36 later/3.x.x/4.x.x/5.x.x, Android 3.08 upwards (Windows 7/8/10/11 Multi touch without driver).

### Please Note:

- Your LCD monitor is Microsoft® Windows® HID (Human Interface Device) compatible if you use the USB touch screen interface. No additional software driver is required for general operation of the touch screen.

**Note:** A calibration tool can be installed for improved touch position accuracy. Please refer to “6.3.1 Optional Calibration Tool Install”.

### 5.3.1 Optional Calibration Tool Install

To calibrate the touch screen in Windows 7/8/10/11 environment:

1. Tap Start > Control Panel > Hardware and Sound.

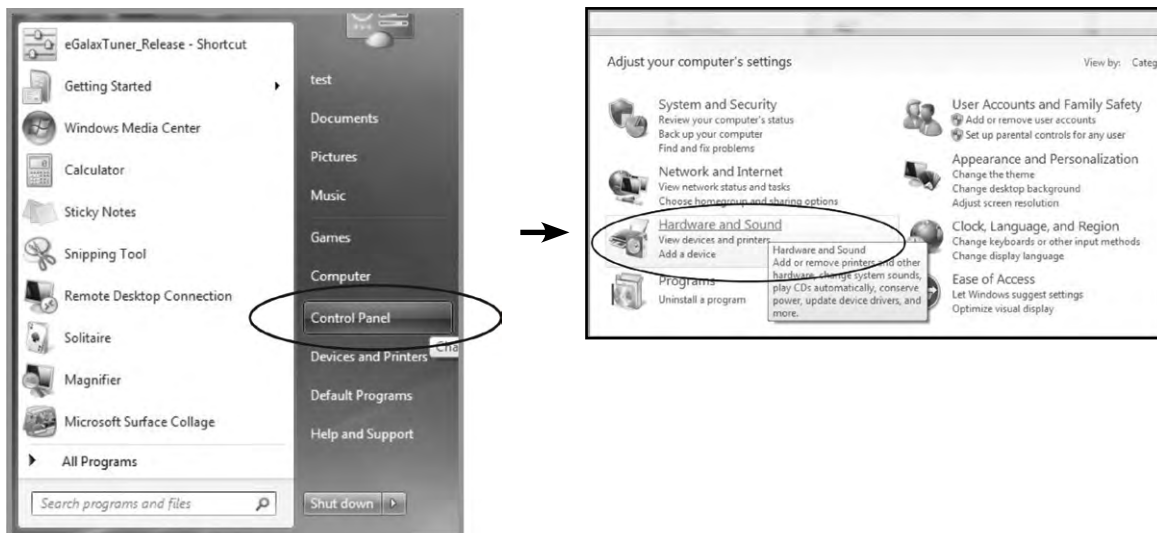

# APPENDIX

2. In Tablet PC Settings, tap “Calibrate the screen for pen or touch input”.

3. On the Display tab, in Display options, tap “Calibrate” and then “Yes” to allow the program to make changes.

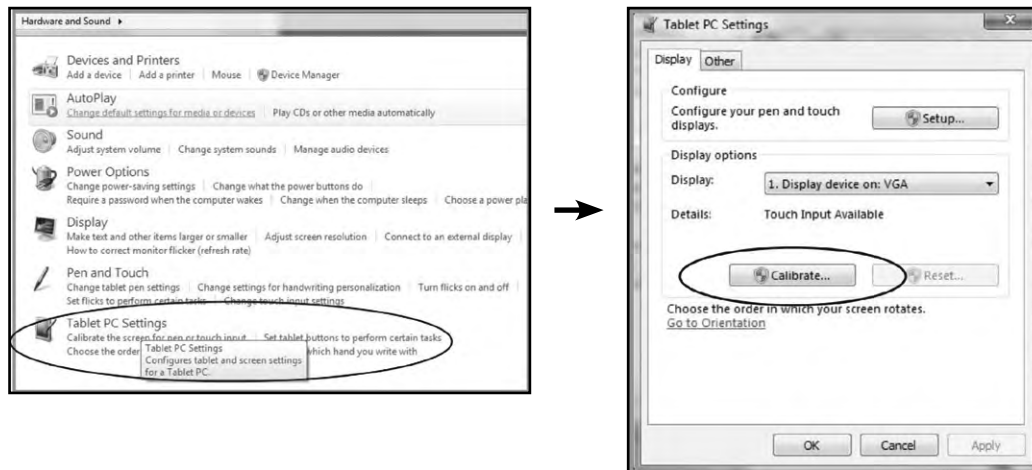

4. Follow the on-screen instructions to calibrate the touch screen.

## 5.3.2 Driver Installation Instructions

If you are using a PC running Windows VISTA, XP, 2000, follow the instructions below:

1. Power on the PC.
2. Make sure the USB cable is connected from the PC to the LCD monitor.
3. Open the corresponding driver folder file.
4. Follow the step-by-step instructions as shown on the pop-up windows.

If you are using a PC running Windows® XP Embedded, follow the instructions below:

- Express:
  1. Power on the computer.
  2. Make sure the USB cable is connected to the computer.
  3. Make sure your EWF (Enhanced Write Filter) is disabled. If your EWF is enabled, please disable the EWF by using the EWF Manager command.
  4. Once the EWF is disabled, click on the XP driver and follow the step-by-step instructions as shown on the pop-up windows.
- Custom:
  1. Power on the computer.
  2. Make sure the USB cable is connected to the computer.
  3. Follow the step-by-step instructions found in the driver folder file.

# APPENDIX

If you are using a PC running Windows® CE, follow the instructions below:

1. Power on the computer.
2. Make sure the USB cable is connected to the computer.
3. Using Platform Builder, build an image file by following the step-by-step instructions found in the driver folder file.

If you are using a PC running Linux, Android 2.1 upward and 4.0, Apple® Mac OS, follow the instructions below:

1. Power on the computer.
2. Make sure the USB cable is connected to the computer.
3. Follow the step-by-step instructions found in the driver folder file.

## 5.4 Cleaning

### Front Panel Cleaning Instructions

- The front of the monitor has been specially treated. Wipe the surface gently using only a cleaning cloth or a soft, lint-free cloth.
- If the surface becomes dirty, soak a soft, lint-free cloth in a mild detergent solution. Wring the cloth to remove excess liquid. Wipe the surface of the monitor to remove dirt. Then use a dry cloth of the same type to dry.
- Do not use volatile substances such as insect sprays, solvents and thinners.

### Cabinet Cleaning Instructions

- If the cabinet becomes dirty, wipe the cabinet with a soft, dry cloth.
- If the cabinet is extremely dirty, soak a lint-free cloth in a mild detergent solution. Wring the cloth to remove as much moisture as possible. Wipe the cabinet. Use another dry cloth to wipe over until the surface is dry.
- Do not allow any water or detergent to come into contact with the surface of the monitor. If water or moisture gets inside the unit, operating problems, electrical and shock hazards may result.
- Do not scratch or hit the cabinet with fingers or hard objects of any kind.
- Do not use volatile substances such as insect sprays, solvents and thinners on the cabinet.
- Do not place anything made from rubber or PVC near the cabinet for any extended periods of time.



# APPENDIX

## 5.5 Troubleshooting

Problems	Possible Cause and Solution
No picture.	<ul style="list-style-type: none"> <li>• Check if the LCD monitor is turned ON.</li> <li>• Check if the power adapter is properly connected to the LCD monitor.</li> <li>• Check if the power cord is plugged into the power outlet and to the power adapter.</li> <li>• Check if the LCD monitor is properly connected to the input source.</li> <li>• Check if the input source is turned ON.</li> <li>• Check if the input source is in standby mode, move the mouse or press any key to wake it up.</li> </ul> <div style="border: 1px solid gray; padding: 5px; margin-top: 10px;"> <p><b>Note:</b> Do not connect the USB cable to the LCD monitor in order to charge your laptop. Doing so will disable the LCD monitor to wake up from standby mode by simply touching the screen.</p> </div>
Partial image or incorrectly displayed image.	<ul style="list-style-type: none"> <li>• Check to see if the resolution of your computer is higher than that of the LCD monitor.</li> <li>• Reconfigure the resolution of your computer to make it less than or equal to 1920 x 1080 .</li> </ul>
Image position is incorrect.	<ul style="list-style-type: none"> <li>• For VGA input, adjust the “H-Position (Horizontal Position)” and “V-Position (Vertical Position)” settings in Picture menu. Refer to page 27.</li> </ul>
The displayed texts are blurry.	<ul style="list-style-type: none"> <li>• For VGA input, run the Auto Adjust function in Picture menu. Refer to page 28.</li> </ul>
Red, blue, green, white dots appear on the screen.	<ul style="list-style-type: none"> <li>• There are millions of micro transistors inside the LCD monitor. It is normal for a few transistors to be damaged and to produce spots. This is acceptable and is not considered a failure.</li> </ul>
Faint shadows from a static image appear on the screen.	<ul style="list-style-type: none"> <li>• Turn off the LCD monitor for extended periods of time.</li> <li>• Use a screen saver or a black and white image and run it for extended periods of time.</li> </ul>
Dew formed on the LCD monitor.	<ul style="list-style-type: none"> <li>• This normally happens when the LCD monitor is moved from a cold room to a hot room temperature. Do not turn ON the LCD monitor, wait for the dew condensation to disappear.</li> </ul>

# SPECIFICATIONS

## 6.1 Monitor Specifications

TX-2202A		
Panel	Panel Size	21.5"
	Max. Resolution	FHD 1920 x 1080
	Pixel Pitch	0.248 mm
	Brightness	250 cd/m <sup>2</sup>
	Contrast Ratio	1000:1
	Viewing Angle (H/V)	178°/178°
	Display Colour	16.2M
	Response Time	5 ms
	Surface Treatment	Anti-Glare Treatment (Haze 25%), 3H Hard Coating
Frequency (H/V)	H Freq.	30 kHz-84 kHz
	V Freq.	50 Hz-76 Hz
Input	DisplayPort	x 1
	HDMI	1.4 x 1
	VGA	15-Pin D-Sub x 1
External Control	RJ11	Connect the wired OSD controller (optional, not supplied)
Audio	Audio In	Stereo Audio Jack (3.5 mm)
	Internal Speakers	2W x 2
Touch Screen	Technology	Projective Capacitive
	Positional Accuracy	± 2.5 mm
	Panel Interface	USB (Type-B)
	Multi-touch Plug & Play	10-point touch Windows® 7, 8, 10, 11, Mac OS 10.10-10.14
	Single Touch Support by Driver	Windows VISTA/XP/2000/CE/XP Embedded
	Multi-touch Support by Driver	10-point touch for Linux Android 3.08 or later
Power	Power Supply	External
	Power Requirements	12V, 4.16A/12V, 5.0A for TX-2202A white
	On Mode	15W (On)
	Stand-by Mode	<0.7W
	Off Mode	<0.3W
Glass	Thickness	2.05 mm (0.08")
	Transmission Rate	> 90%
	Hardness	> 7H
Operating Conditions	Temperature	0°C-40°C (32°F-104°F)
	Humidity	20%-80% (non-condensing)
Storage Conditions	Temperature	-20°C-60°C (-4°F-140°F)
	Humidity	10%-90% (non-condensing)
Mounting	VESA FPM PMI	Yes (100 x 100 mm)
Stand	Tilt	-5° to 90°
Dimensions	Product with Base (W x H x D)	528.6 x 346.7 x 214.2 mm (20.8" x 13.7" x 8.4")
	Product w/o Base (W x H x D)	528.6 x 324.3 x 48.5 mm (20.8" x 12.8" x 1.9")
	Packaging (W x H x D)	610.0 x 460.0 x 320.0 mm (24.0" x 18.1" x 12.6")
Weight	Product with Base	6.7 kg (14.8 lb)
	Product w/o Base	4.8 kg (10.6 lb)
	Packaging	9.8 kg (21.6 lb)

**Note:** All specifications are subject to change without prior notice.

# SPECIFICATIONS

## 6.2 Monitor Dimensions

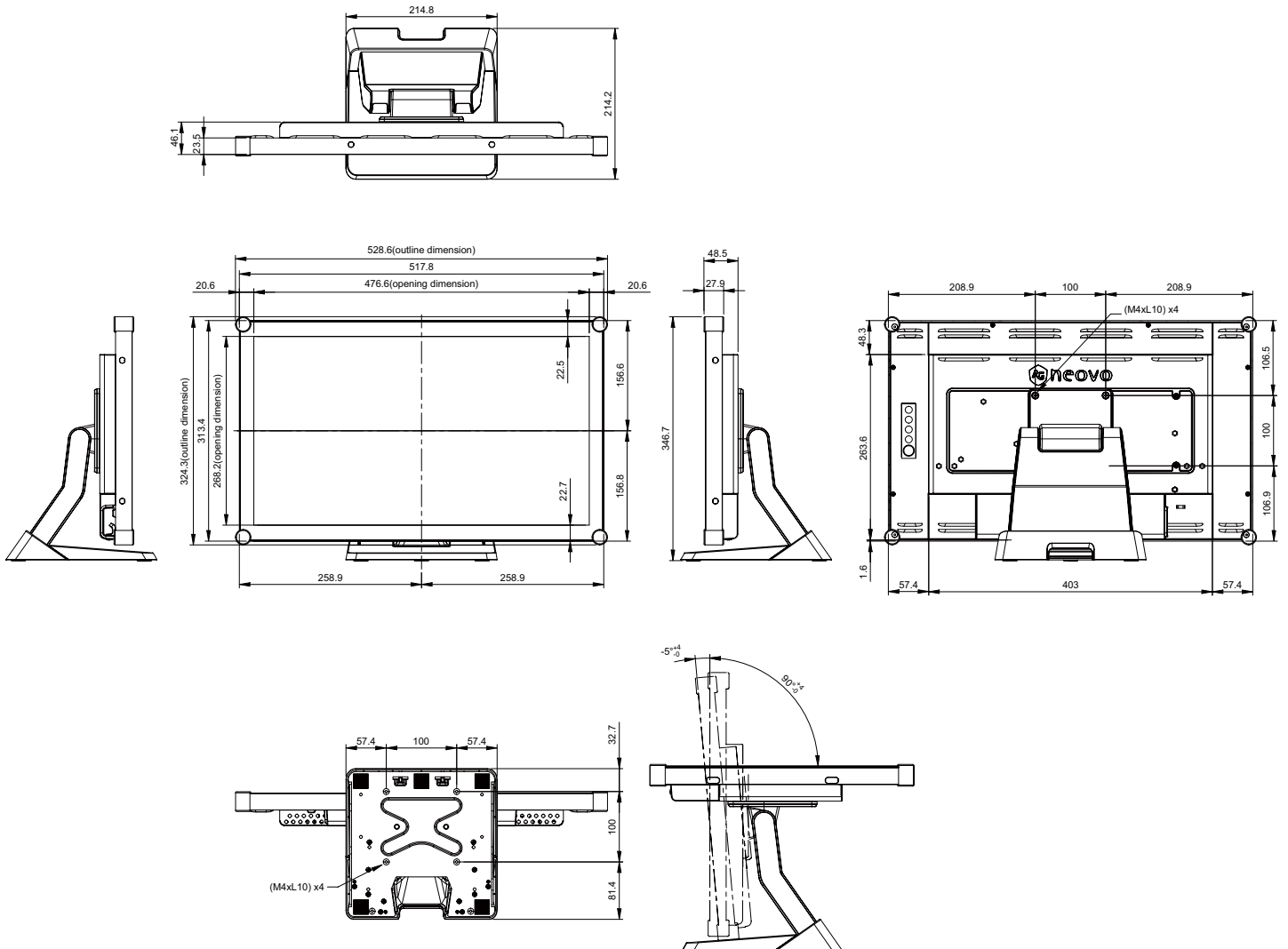

### AG Neovo

Company Address: 5F-1, No. 3-1, Park Street, Nangang District, Taipei, 11503, Taiwan.

Copyright © 2023 AG Neovo. All rights reserved.

TX2A00\_UM\_V010

TX-2202A Eprel registration number: 1372216