

MotionCam Fibra

Wired motion detector with a photo camera.



The device is compatible only with hubs supporting Fibra protocol. Find the detailed information by QR code or the link:

<https://ajax.systems/support/devices/motioncam-fibra/>

MotionCam Fibra is the device of the new Fibra wired product line. Such devices can only be purchased, installed and administered by accredited Ajax partners.

Up to 12 m detection distance and 88.5°/80° viewing angles

Up to 640×480 pixels photo resolution

Immunity to pets with a weight of up to 20 kg and height up to 50 cm

IR backlight for night mode pictures

SmartDetect software algorithm to prevent false alarms

Available in two versions: with and without **Photo on demand** functionality

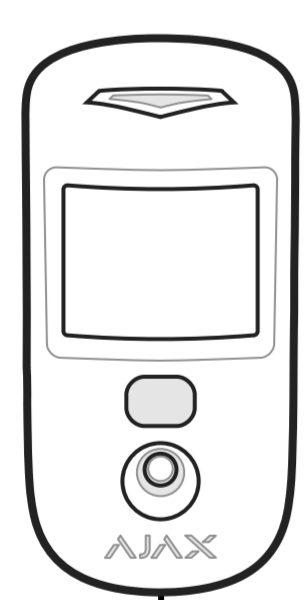

communication technology

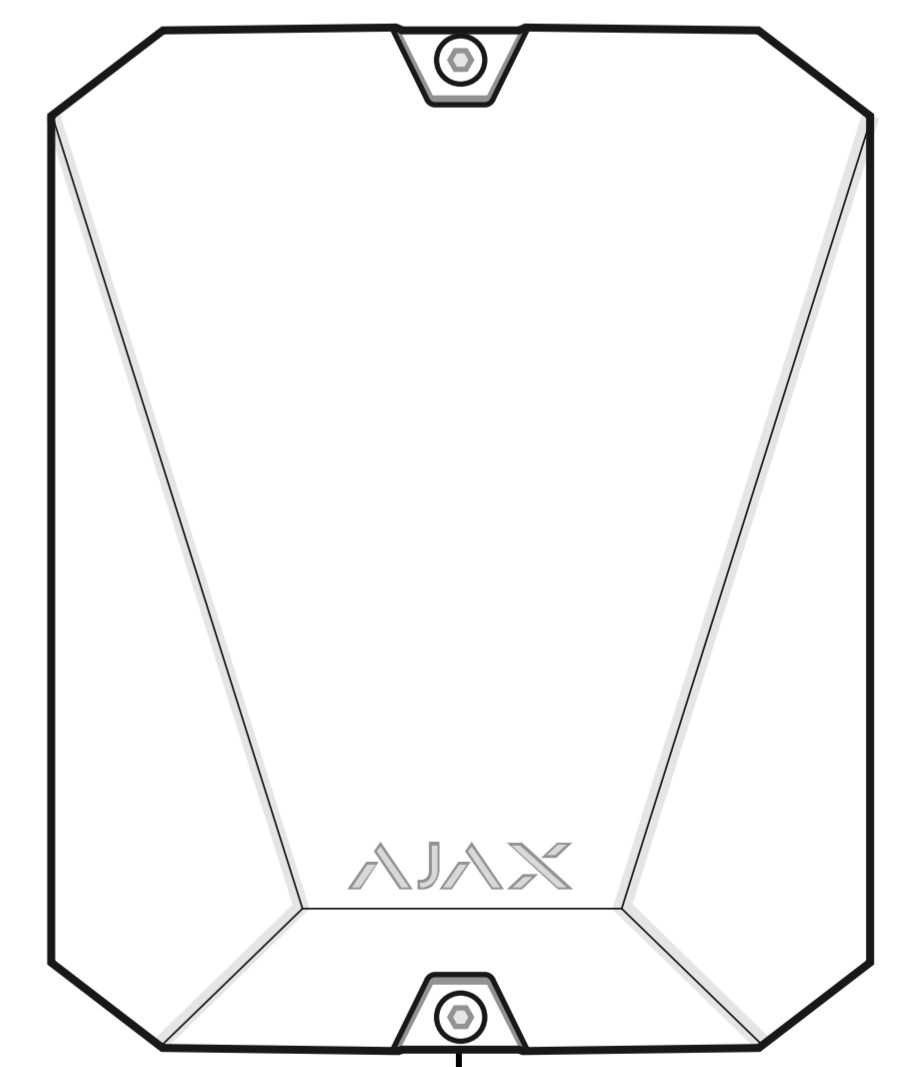

Fibra is a **two-way wired protocol**, ensuring fast and secure communication between hubs and devices. Based on a **bus connection method**, Fibra delivers instant data-rich alarms: security companies and users know which device was triggered, when and where it happened.

Fibra features **encryption** and **authentication** to prevent forgery, and **polling** to display device's status in real time. Supporting **up to 2,000 m** of wired connectivity, Fibra is ready to protect any facilities, and deliver **the best user experience** for both end users and installers.

PIR sensor coverage angles

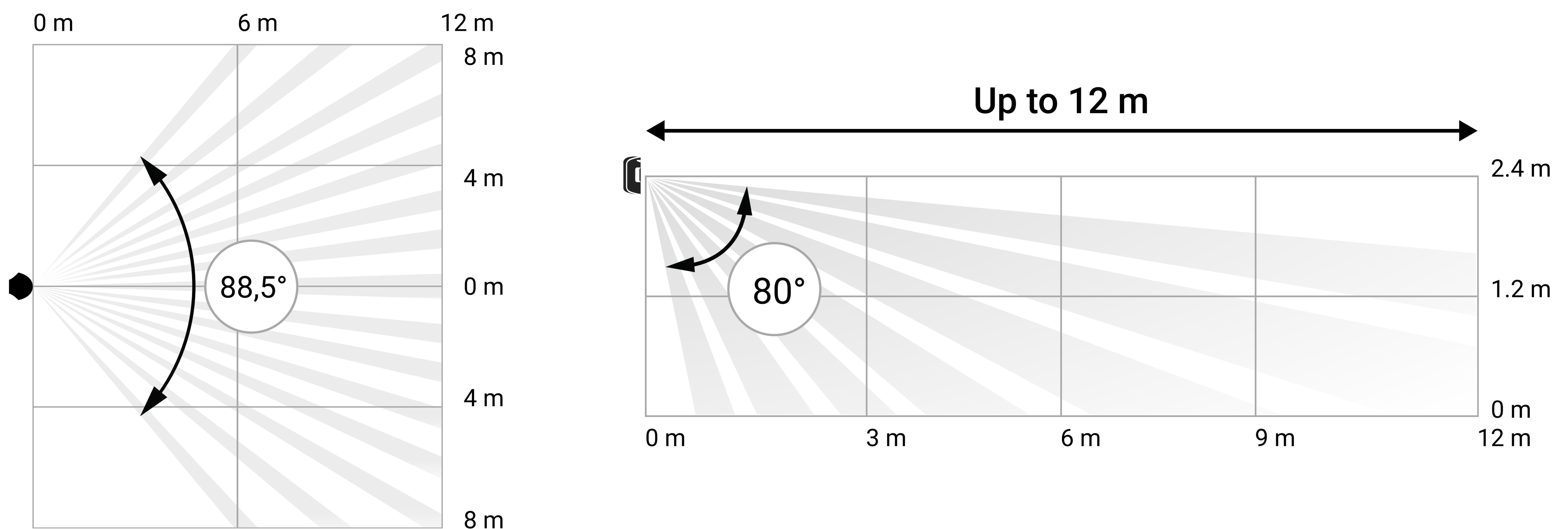

Motion detected. Alarm raised. Evidence captured.

MotionCam Fibra recognizes intrusion from the very first steps on the protected facility and confirms it with an animated series of photos. Visual verification helps to instantly assess the situation, relieving users from unnecessary anxiety, and security companies – from false calls of patrols.

Privacy first

The detector activates its camera when the security system is armed and motion is detected. Visual alarm verifications can only be seen by users with access to the hub's event feed and by security company employees if the security system is connected to a monitoring station.

If the **Photo on demand** function is activated, the detectors can take a photo upon the command of a system user or PRO user with access rights. Requested photos are always recorded in the hub's events feed.

Photos are encrypted at every stage of transmission. While stored on the Ajax Cloud server, no pictures are processed or analysed.



MotionCam Fibra is available in two versions: with and without **Photo on demand** functionality.

Monitoring software that supports Ajax photo verification

HORUS

Horus

Manitou®

Manitou



SBN



Sentinel



WEB BUNCHER™

WBB

See the full list by the link: ajax.systems/connecting-to-cms/

System features

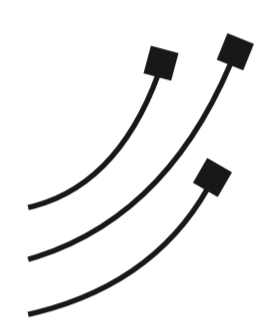

Bus connection method

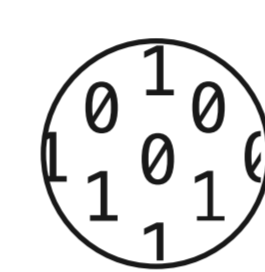

Up to 2,000 m of two-way encrypted communication with hub

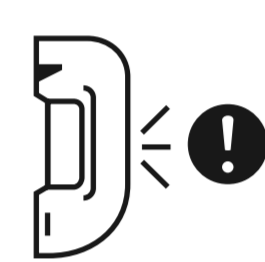

Tampering alarm notification

12-300
sec

Hub polls connected devices with the lowest possible frequency



Configuring via a smartphone or desktop app

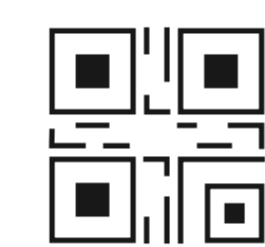

Pairing via QR code or bus scanning

Technical specifications

Compliance with standards

EN 50131 (Grade 2)
PD 6662:2017

Compatibility

Hubs

Hub Hybrid (2G)
Hub Hybrid (4G)

Range extenders

no

Power supply

24 V $\overline{=}$, up to 60 μ A

| | | | |
|---|--|-------------------------|--|
| <p>Communication with control panel</p> | <p> Fibra communication technology</p> <p>Communication range up to 2,000 m with U/UTP cat.5 4×2×0,51 cable</p> <p>Polling interval 12–300 sec Set automatically</p> | <p>Motion detection</p> | <p>Motion detection distance up to 12 m</p> <p>Detection angles horizontally – 88.5° vertically – 80°</p> <p>Sensitivity 3 levels Set by admin in the app</p> <p>Pet immunity Filters false alarms on pets weighing up to 20 kg and up to 50 cm height</p> |
| <p>Photo verification</p> | <p>Photo resolution in pixels 640×480 320×240 (default) 160×120 Set by admin in the app</p> <p>IR backlight yes</p> <p>Pictures in a series from 1 to 5 pcs Set by admin in the app</p> | <p>Installation</p> | <p>Operating temperature range from –10°C to +40°C</p> <p>Operating humidity up to 75%</p> <p>Ingress protection IP50</p> |
| <p>Casing</p> | <p>Colour white, black</p> <p>Dimensions TBS</p> <p>Weight TBC</p> <p>Tampering alarm yes</p> | <p>Complete set</p> | <p>MotionCam Fibra SmartBracket Installation kit Quick Start Guide</p> |