



Bullet Camera

Hardware Manual

E48

Ver. 2015/03/31



ACTi
Connecting Vision

Table of Contents

Precautions 4

Safety Instructions	6
---------------------------	---

Introduction 7

List of Models.....	7
Package Contents.....	8
Physical Description	9

Installation Procedures 10

Step 1: Prepare for Installation.....	10
Step 2: Mount the Camera.....	11
Step 3: Waterproof and Connect the Cable(s).....	13
How to Use the Cable Gland.....	14
How to Use the Conduit Gland.....	18
Step 4: Connect to Network.....	22
Step 5: Access the Camera Live View.....	22
Step 6: Complete the Installation	22

Other Cable Connections (Optional) 23

How to Connect DI/DO Devices	23
How to Connect Audio Devices	27

Other Adjustments and Accessories 28

How to Adjust the Viewing Angle and Focus	28
How to Attach the Sunshield	30
How to Open the Back Cover.....	31
How to Close the Back Cover	31
How to Insert the Memory Card.....	33
How to Remove the Memory Card.....	33

How to Reset the Camera..... 34

Accessing the Camera 35

Configure the IP Addresses 35
 Using DHCP Server to Assign IP Addresses..... 35
 Using the Default Camera IP Address..... 37
Access the Camera..... 39

Precautions

Read these instructions

You should read all the safety and operating instructions before using this product.

Heed all warnings

You must adhere to all the warnings on the product and in the instruction manual. Failure to follow the safety instruction given may directly endanger people, cause damage to the system or to other equipment.

Servicing

Do not attempt to service this video device yourself as opening or removing covers may expose you to dangerous voltage or other hazards. Refer all servicing to qualified service personnel.

Trademarks

All names used in this manual are probably registered trademarks of respective companies.

Liability

Every reasonable care has been taken during the writing of this manual. Please inform your local office if you find any inaccuracies or omissions. We cannot be held responsible for any typographical or technical errors and reserve the right to make changes to the product and manuals without prior notice.

Federal Communications Commission Statement



This equipment has been tested and found to comply with the limits for a class B digital device, pursuant to Part 15 of the FCC Rules. These limits are designed to provide reasonable protection against harmful interference in a residential installation. This equipment generates, uses, and can radiate radio frequency energy and, if not installed and used in accordance with the instructions, may cause harmful interference to radio communications. However, there is no guarantee that interference will not occur in a particular installation. If this equipment does cause harmful interference to radio or television reception, which can be determined by turning the equipment off and on, the user is encouraged to try to correct the interference by one or more of the following measures:

- Reorient or relocate the receiving antenna.
- Increase the separation between the equipment and receiver.
- Connect the equipment into an outlet on a circuit different from that to which the receiver is connected.
- Consult the dealer or an experienced radio/TV technician for help.

Warning: Changes or modifications to the equipment that are not expressly approved by the responsible party for compliance could void the user's authority to operate the equipment.

European Community Compliance Statement



This product has been tested and found to comply with the limits for Class B Information Technology Equipment according to European Standard EN 55022 and EN 55024. In a domestic environment, this product may cause radio interference in which cause the user may be required to take adequate measures.

Safety Instructions

Cleaning

Disconnect this video product from the power supply before cleaning.

Attachments

Do not use attachments not recommended by the video product manufacturer as they may cause hazards.

Don't use accessories not recommended by the manufacturer

Install other devices (such as PoE injector, alarm, etc.) that will be used with the camera in a dry place protected from weather.

Servicing

Do not attempt to service this video product yourself as opening or removing covers may expose you to dangerous voltage or other hazards. Refer all servicing to qualified service personnel.

Damage Requiring service

Disconnect this video product from the power supply immediately and refer servicing to qualified service personnel under the following conditions.

- 1) When the power-supply cord or plug is damaged
- 2) If liquid has been spilled, or objects have fallen into the video product.
- 3) If the video product has been directly exposed to rain or water.
- 4) If the video product does not operate normally by following the operating Instructions in this manual. Adjust only those controls that are covered by the instruction manual, as an improper adjustment of other controls may result in damage, and will often require extensive work by a qualified technician to restore the video product to its normal operation.

Safety Check

Upon completion of any service or repairs to this video product, ask the service technician to perform safety checks to determine if the video product is in proper operating condition.

Introduction

List of Models

This hardware manual contains the following models:

E48		10MP Bullet with D/N, Adaptive IR, Basic WDR, Vari-focal lens

Package Contents

Camera	Bracket Plate	Sunshield
		
Drill Template	Mounting Screw Kit	Sunshield Screw Kit
		
Conduit Gland	Cable Gland	Washers x 2
		
Terminal Block	Quick Installation Guide	Warranty Card
		

NOTE: The above pictures are for reference only; actual items may slightly vary.

Physical Description



	Item	Description
1	Memory Card Slot	Insert a memory card into this slot for local recording purposes. See How to Insert the Memory Card on page 33 for more information. NOTE: Supports microSDHC and microSDXC cards.
2	Reset Button	Restores the factory default settings of the camera. Resetting the camera must be done while the power is on. See How to Reset the Camera on page 34 for more information.
3	Power LED	The Power LED turns on when the camera is powered on and goes off once the initial boot up process is complete.
4	Audio Input	This jack connects to an audio input device, such as a microphone with built-in amplifier. NOTE: Make sure that the connected audio input device has a built-in amplifier. Connecting an ordinary microphone will dwarf sounds and will result in inaudible recording.
5	Audio Output	This jack connects to an audio output device, such as a speaker.
6	Digital Input / Output (DI/DO)	This connector connects to digital input or output devices, such as an alarm trigger, panic button, etc. Digital Input (DI) and Digital Output (DO) devices are used in applications like motion detection, event triggering, alarm notifications, etc. See How to Connect DI/DO Devices on page 23 for more information.
7	Ethernet Port	The Ethernet port connects to a network using a standard Ethernet cable.

Installation Procedures

Step 1: Prepare for Installation

1. If necessary, install a memory card into the memory card slot of the camera. See [How to Insert the Memory Card](#) on page 33 for detailed instructions.
2. Attach the bracket to the camera.

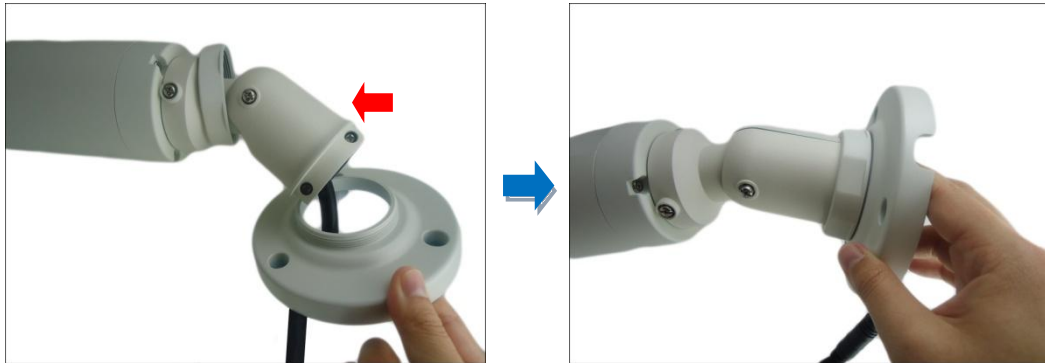

3. Attach the supplied drill template sticker on the ceiling or wall where the camera will be installed.
4. Drill three (3) screw holes based on the drill template.

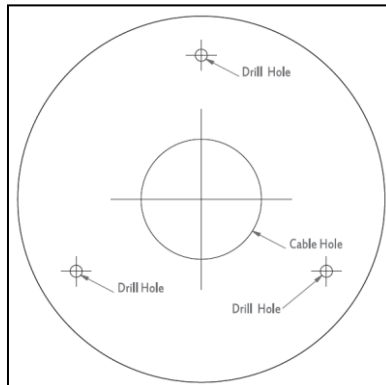

5. If connecting digital input or output device, such as alarms, sensors, etc., to the camera, prepare the terminal block for connection. See [How to Connect DI/DO Devices](#) on page 23 for detailed instructions.
6. Determine whether the camera cable will go through the surface or be routed along the surface.

If the camera cable will go through a hole on the surface, do the following:

- a. Drill the cable hole (based on the drill template) on the surface.
- b. Route the cable(s) from the network side through the hole on the surface.

- c. Connect the cables, see [Step 3: Waterproof and Connect the Cable\(s\)](#) on page 13.
- d. Push the cable(s) into the cable hole of the surface, then proceed to [Step 2: Mount the Camera](#) on page 11.

If the camera cable will be routed along the surface, continue with the next step.

Step 2: Mount the Camera

NOTE: For simplicity of documentation, the succeeding illustrations show the camera as mounted on the ceiling. Same procedures apply for mounting the camera on the wall.

1. Route the cable:
 - ***If the cable will go through a hole on the surface,*** push the cable(s) through the hole on the surface.
 - ***If the cable will go along the surface,*** route the cable through the gap on the bracket.



2. Tighten the set screw on the bracket plate to fixed its position.



3. Attach the camera to the surface using the three (3) supplied screws.

4. Adjust the camera installation angle and orientation, and then tighten the screws to fix the position.

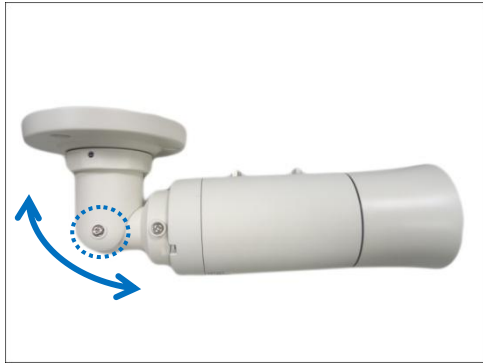

Set Installation Angle

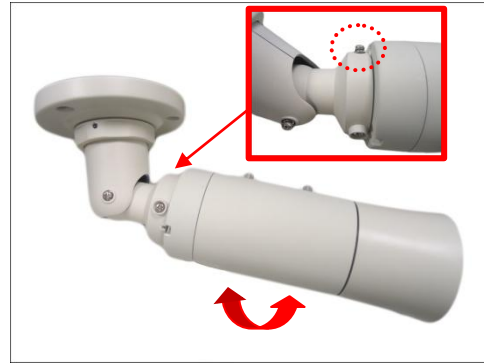



Set Viewing Orientation

Step 3: Waterproof and Connect the Cable(s)

NOTE: The succeeding pictures are for reference only; actual connectors may slightly differ.

The camera and the pre-installed network cable, “pigtail”, are resistant to salt, water, weak acid, alcohol, oil, grease and other common solvents. However, users must ensure that the cable connection and the network side cable itself are also protected from different environmental factors.

For Ethernet connection, there are two waterproofing methods.

Bundled Accessory	Description
<p data-bbox="234 734 389 763">Cable Gland</p> 	<p data-bbox="646 734 1315 909">Use this solution when connecting an Exterior-grade Ethernet cable between the camera and a Power-over-Ethernet (PoE) switch or injector. See How to Use the Cable Gland on page 14.</p>
<p data-bbox="234 1120 411 1149">Conduit Gland</p> 	<p data-bbox="646 1120 1334 1344">Use this solution when connecting a standard indoor Ethernet cable between the camera and a Power-over-Ethernet (PoE) switch / injector. A flexible conduit (trade size 1/2”) is required to house the Ethernet cable. See How to Use the Conduit Gland on page 18.</p> <p data-bbox="646 1375 1294 1456">NOTE: The flex conduit is not included in the package and must be purchased separately.</p>

When connecting input or output devices, such as alarms, sensors, microphones, etc., connect the terminal block and/or the audio jack(s) to the camera before connecting to the network. See [Other Cable Connections](#) on page 23 for detailed instructions.

How to Use the Cable Gland

This section describes how to waterproof the cable-out or “pigtail” of the camera using the bundled cable gland. An exterior-grade Ethernet cable is required. The camera may or may not have to be installed first before doing the cable connections (see related installation procedures for details).

Before connection, prepare the following materials:

Cable Gland (included in the camera package)	Washer (included in the camera package)
	
Exterior-Grade Ethernet Cable (not included in the package)	
	 <p>NOTE:</p> <ul style="list-style-type: none"> • Exterior-grade cables are already waterproof. <i>Not included in the package.</i> • Use only RJ-45 connectors without sleeve.

Perform the following to waterproof the “pigtail” using the cable gland:

1. Disassemble the cable gland as shown below:

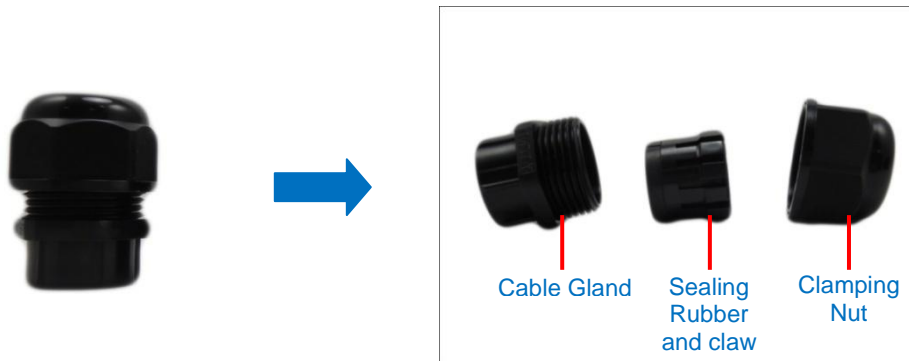

2. Insert the clamping nut into the Ethernet cable.



3. Insert the sealing rubber with claw.

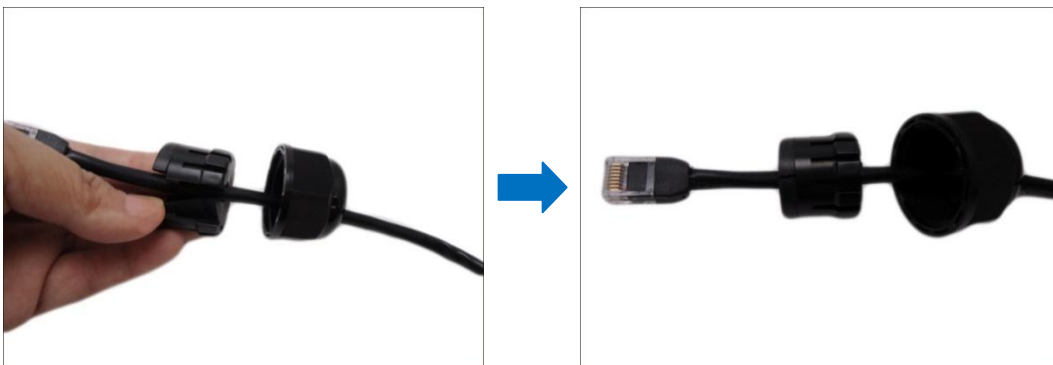

4. Attach one (1) supplied rubber ring on the gland body (smooth end).

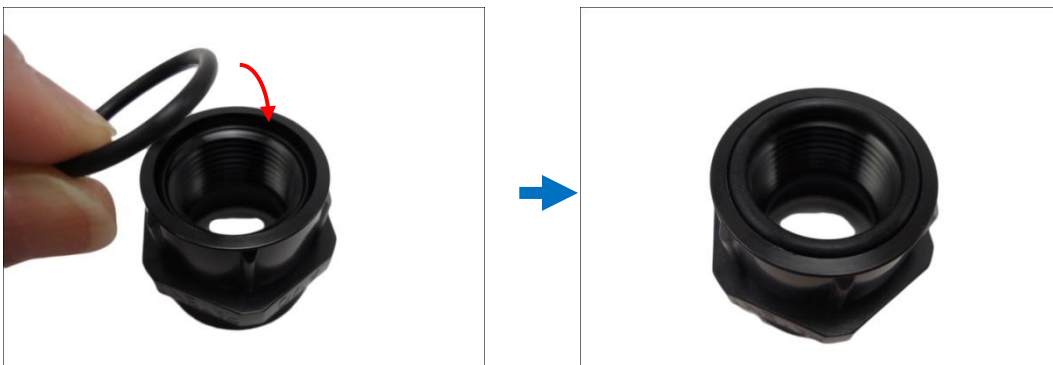

NOTE: Make sure the rubber ring is completely aligned on the gap on the gland body.

5. Attach the gland body to the Ethernet port of the camera.

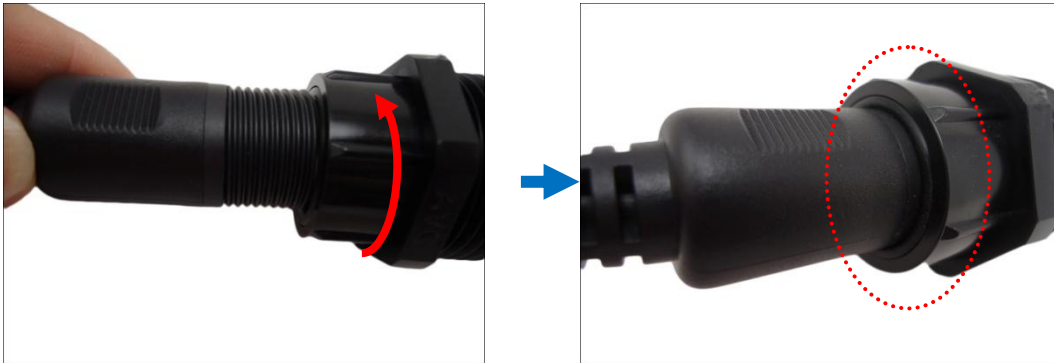

IMPORTANT!

Make sure the rubber ring is completely aligned and flat on the gland body to avoid possible water leakage.

6. Connect the Ethernet cable connector to the Ethernet port of the camera.



7. Insert the sealing rubber and claw into the cable gland body.

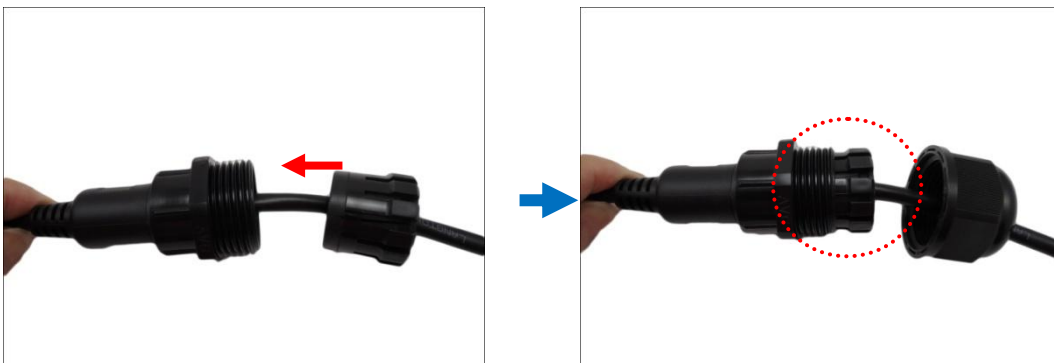

8. Attach the clamping nut to the cable gland body. Make sure the clamping nut is tightly secured and the sealing rubber is squeezed in to avoid water leakage.

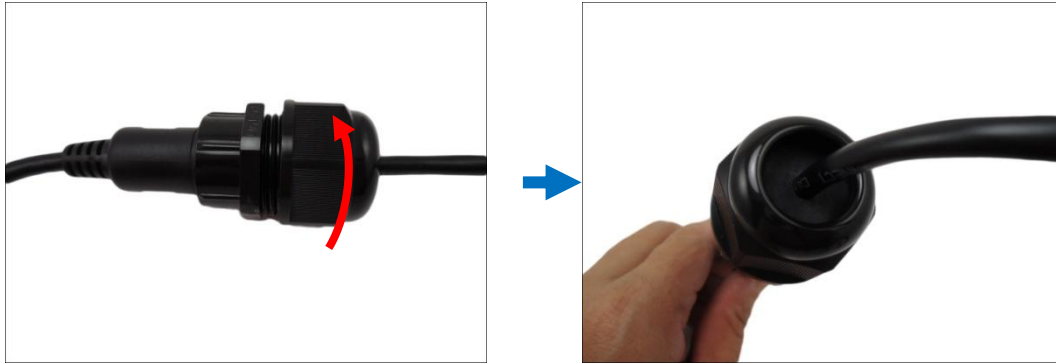

How to Use the Conduit Gland

This section describes how to waterproof the cable-out or “pigtail” of the camera using the bundled conduit gland and flexible conduit. This is the recommended solution if an exterior-grade Ethernet cable is not available.

Before connection, prepare the following materials:

Conduit Gland (included in the camera package)	Flexible Conduit 1/2" Trade size (not included in the package)
	 <p>NOTE: Not included in the package.</p>
Washer (included in the camera package)	Ethernet Cable CAT 5 or CAT 6 (not included in the package)
	

Perform the following to waterproof the “pigtail” using the conduit gland:

1. Disassemble the conduit gland as shown below:

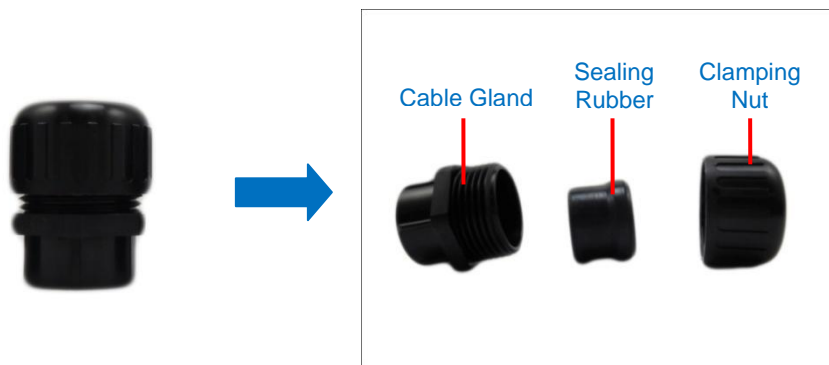

2. Pull the Ethernet cable through the flex conduit. Leave enough length of the cable outside the flex conduit.



3. Insert the clamping nut through the flex conduit.

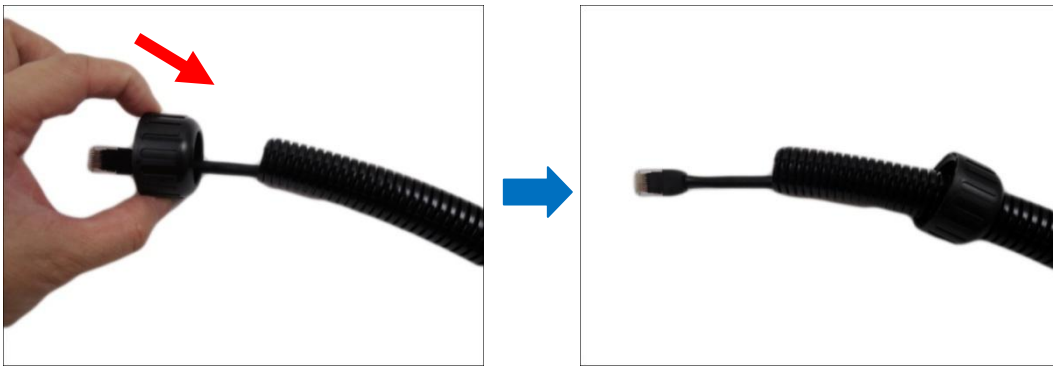

4. Insert the sealing rubber and fix it at the end of the flex conduit.

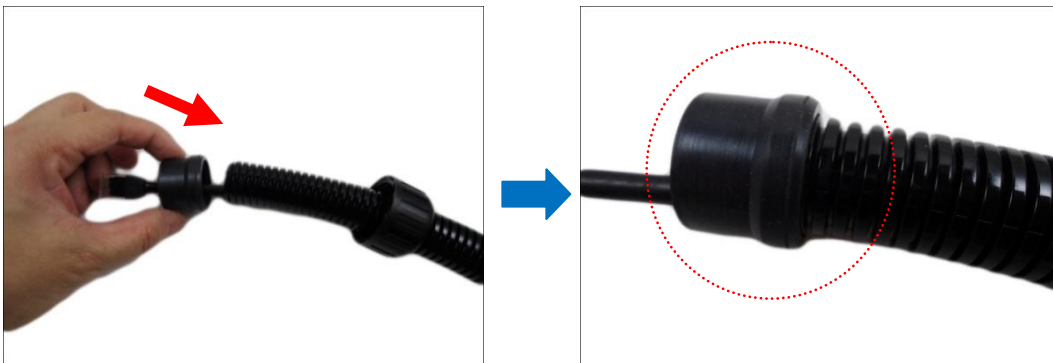

5. Attach one (1) supplied rubber ring on the gland body (smooth end).

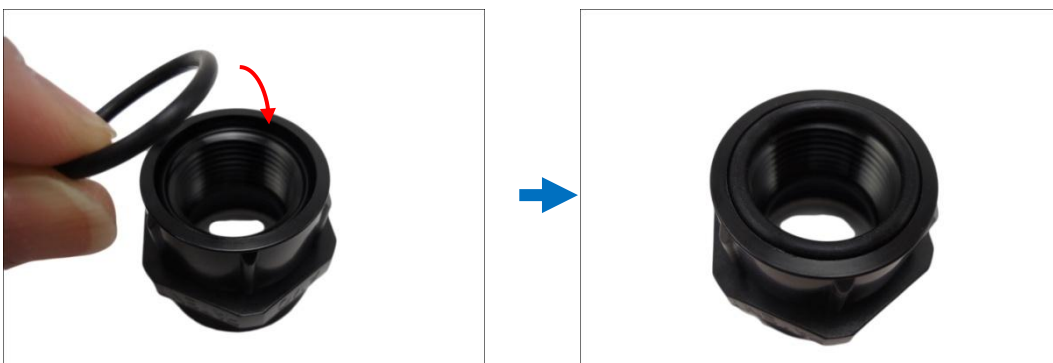

NOTE: Make sure the rubber ring is completely aligned on the gap on the gland body.

6. Attach the gland body to the Ethernet port of the camera.

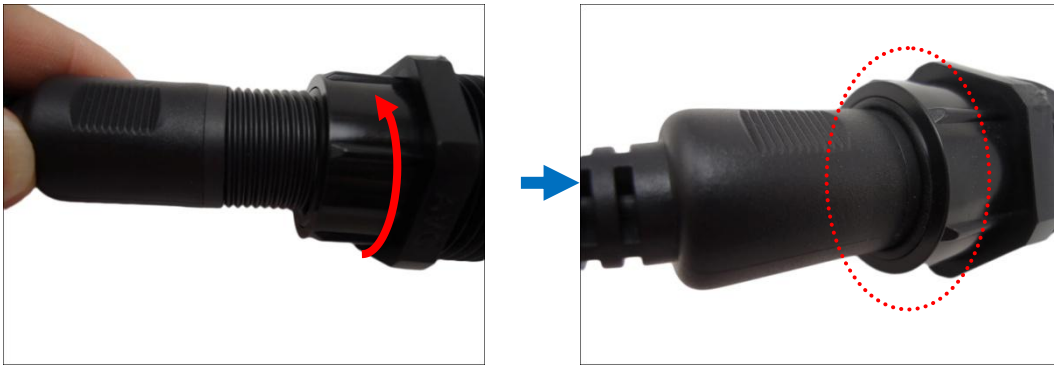

IMPORTANT!

Make sure the rubber ring is completely aligned and flat on the gland body to avoid possible water leakage.

7. Connect the Ethernet connector to the Ethernet port of the camera.



8. Insert the sealing rubber into the conduit gland body.

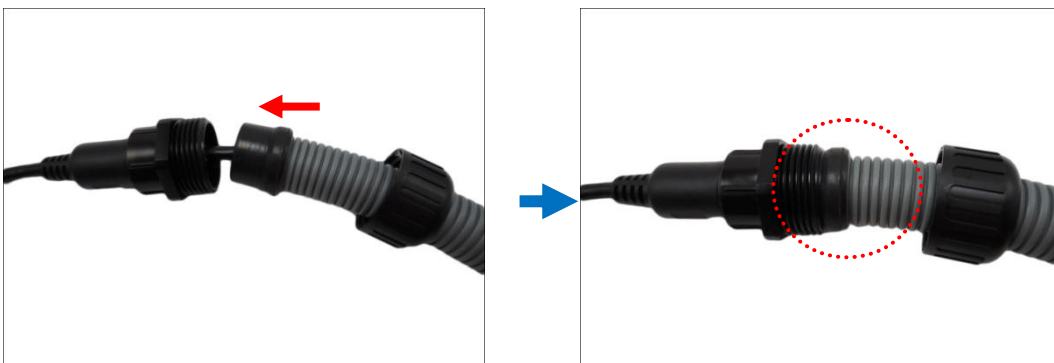

9. Attach the clamping nut to the conduit gland body. Make sure the clamping nut is tightly secured to avoid water leakage.



Step 4: Connect to Network

Connect the other end of the network cable to a switch or injector. Then, connect the switch or injector to a network, PC, and a power source. See Power-over-Ethernet (PoE) connection example below.

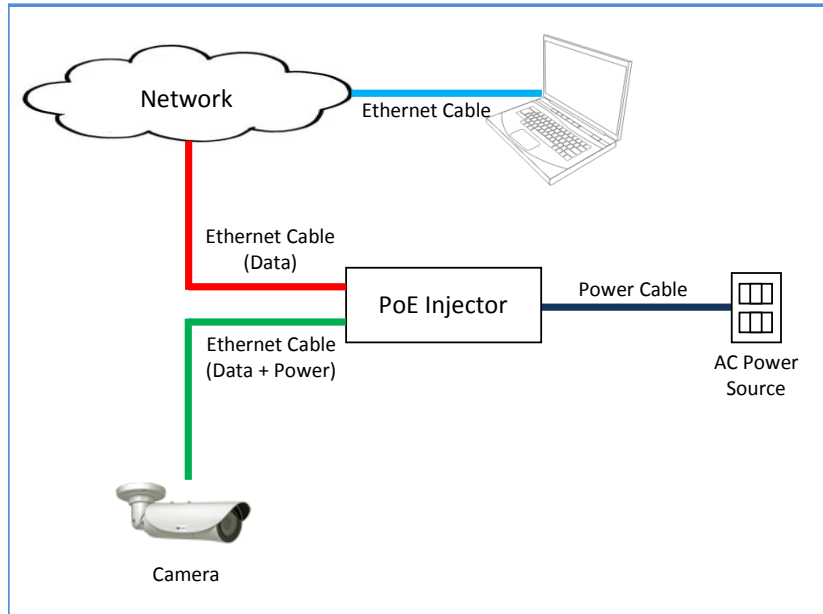

Step 5: Access the Camera Live View

See [Accessing the Camera](#) on page 35 for more information on how to access the Live View of the camera.

Step 6: Complete the Installation

To complete the installation, attach the sunshield to the camera, see [How to Attach the Sunshield](#) on page 30. Below is a sample installation.



Other Cable Connections (Optional)

This section describes the procedures in preparing and connecting Digital Input and Output (DI/DO), such as alarms, sensors, etc., and Audio Input and Output devices. The use of these devices, however, is optional.



NOTE: If these connectors will not be used, leave the caps on to ensure cables remain waterproof and eliminate short-circuit hazards.

How to Connect DI/DO Devices

Depending on your surveillance needs, you may connect one digital input and one digital output device to your camera.

Digital Input (DI) devices can be used to notify the camera about an activity in the camera site. DI can be triggers of events. For example, you can connect a “panic button” to the camera; as such when the panic button is pressed, the alarm signal will be sent through the camera. Other common DI device applications are emergency button, smoke detector, passive infrared sensor, etc.

Digital Output (DO) devices are external devices that are activated by the camera upon an event inside the camera. For example, you can connect an “alarm horn” to the camera; as such when an event occurs inside the camera (e.g. detected intruder), the alarm horn will sound. Other common DO device applications are motion-triggered lights, electric fence, magnetic door locks, etc.

Loosen the screw and insert the wire through the pin slot, then tighten the screw to secure the wire.



To connect digital input / output devices (DI/DO), map the pins to one of the pin combinations below:

Device	Pin	Mapping Instructions
Digital Output (DO)	12V	Connect the wires of the output device to 12V and DO .
	DO	
Digital Input (DI)	GND	Connect the wires of the input device to GND and DI .
	DI	

The table below shows the DI/DO connection specifications:

Device			
DI	Connection design		TTL - compatible logic levels
	Voltage	To trigger (low)	Logic level 0: 0V ~ 0.4V
		Normal (high)	Logic level 1: 3.1V ~ 30V
	Current		10mA ~ 100mA
DO	Connection design		Transistor (Open Collector)
	Voltage & Current		< 24V DC, < 50mA

After mapping the wires to the terminal block, connect the terminal block to the DIO connector of the camera.

Typical Connection

Based on these specifications, if the DI device has a voltage of 0V ~ 30V or the DO device has a voltage of < 24V (< 50mA), then the camera can supply internal power to these devices and there is no need to connect the DI/DO device to an external power source.

In this case, use the **GND** and **DI** pins to connect a DI device and use the **12V** and **DO** pins to connect a DO device. See wiring scheme below:

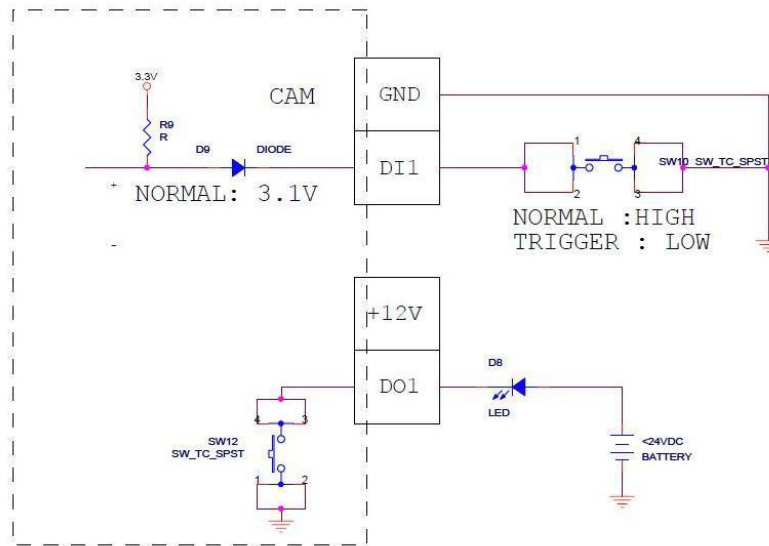

High Voltage DO Device Connection

Even though the camera provides 12V power, this may not be enough for some high voltage DO devices, such as a ceiling light or a motor that opens or closes a gate. In this case, there is a need to connect an external relay. See wiring scheme below:

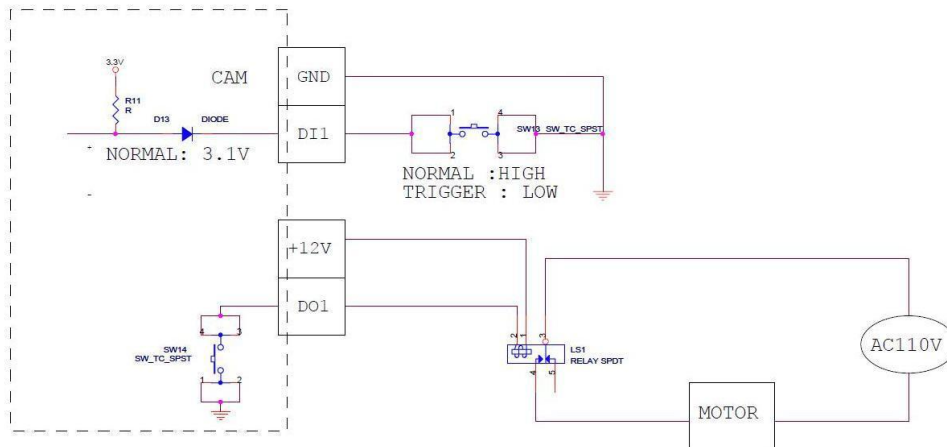

Note that when choosing an appropriate relay, please refer to its specifications and make sure they match the above design. The triggering circuit voltage has to be around 12V DC and the switch-controlled circuit voltage has to match the external power supply (e.g. 110V AC or 220V AC).

The illustration below is a graphic example of connecting a relay to a high voltage DO device.

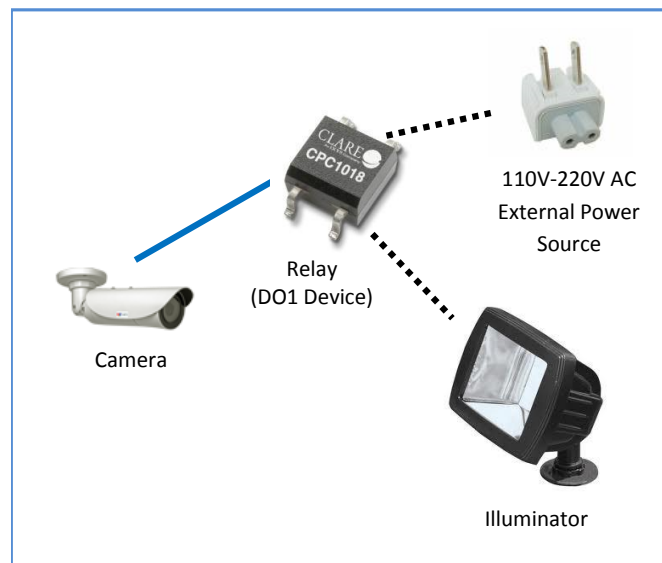

NOTE: For more information on DI/DO connections, please refer to the Knowledge Base article *All about Digital Input and Digital Output* downloadable from the link below (http://www.acti.com/kb/detail.asp?KB_ID=KB20091230001).

How to Connect Audio Devices

Audio input / output devices, such as an active microphone or speaker can be connected to the camera using the supplied terminal block.

If using an audio input device, such as a microphone with a built-in amplifier, connect the device to the **Audio Input** jack (RED) of the camera. If using an audio output device, such as a speaker, connect the device to the **Audio Output** jack (GREEN) jack of the camera.

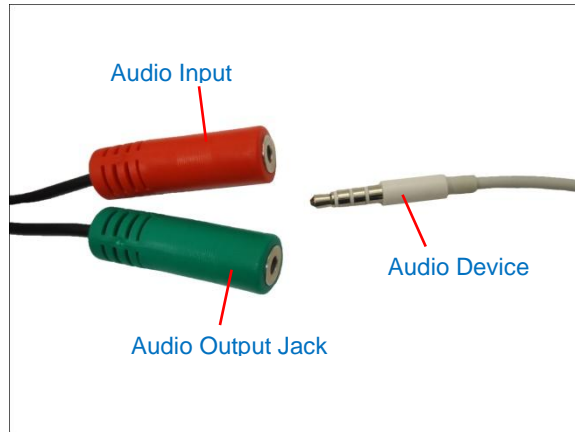

NOTE 1: Make sure that the connected audio input device has a built-in amplifier. Connecting an ordinary microphone will dwarf sounds and will result in inaudible recording.

NOTE 2: If the audio connectors will not be used, leave the rubber caps on to ensure cables remain waterproof and eliminate short-circuit hazards.

Other Adjustments and Accessories

How to Adjust the Viewing Angle and Focus

The camera comes with prefixed focus and viewing angle. In most applications, the camera is ready to use without further adjustments. However, in case there is a need to adjust these configurations, do the following:

1. Open the front cover.



NOTE: A dessicant bag is attached inside the camera, DO NOT remove this bag to keep the interior parts free from moisture.

2. Use a screwdriver to loosen the set screws.

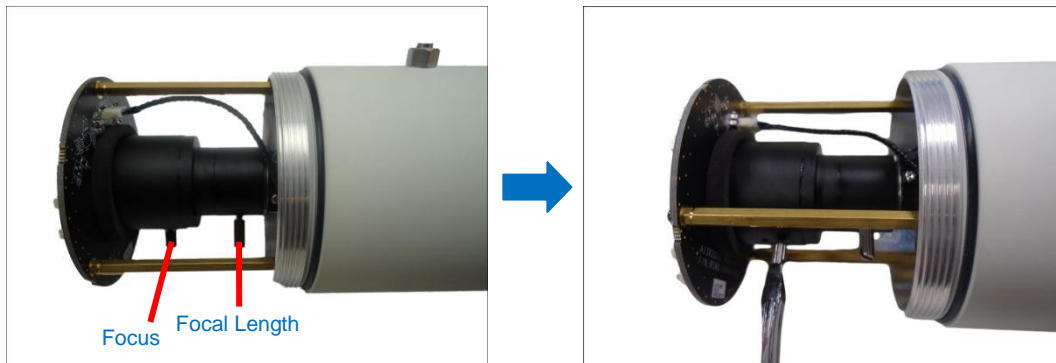

3. Based on the live view from the camera, adjust the focal length and focus of the target area. Then, tighten the set screws to fix their position.

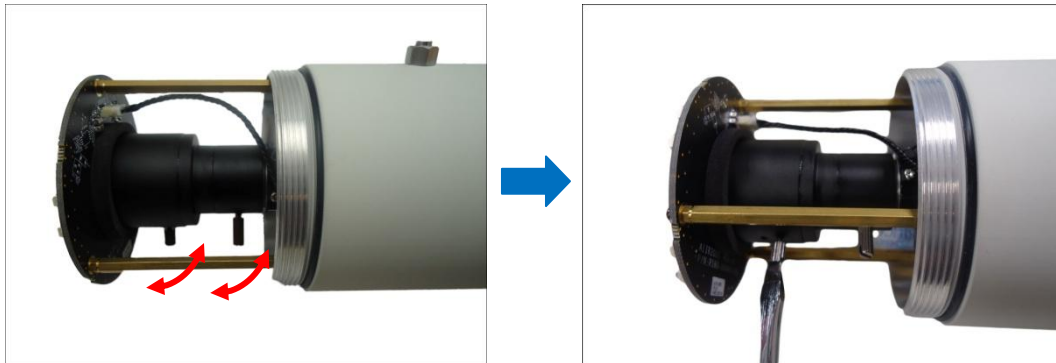

4. When done, close the front cover.

CAUTION: The front cover must be tightly closed to ensure water or dust does not go through any opening.

How to Attach the Sunshield

The use of sunshield is optional if the camera will be installed indoors. However, if the camera will be installed outdoors, attach the sunshield to protect the lens from all types of weather and lighting conditions.

1. Loosely secure the supplied screws and washers to attach the sunshield.



2. Slide to adjust the sunshield to cover the lens as far as possible but out of the camera's live view.



3. Tighten the screws to fix the position of the sunshield.

How to Open the Back Cover

Opening the back cover is necessary when inserting a memory card or resetting the camera. Follow the procedures below to open the back cover.

1. Remove the three (3) screws securing the integrated bracket from the camera back cover and then detach the bracket.



2. Loosen the three (3) screws securing the back cover and open the back cover.

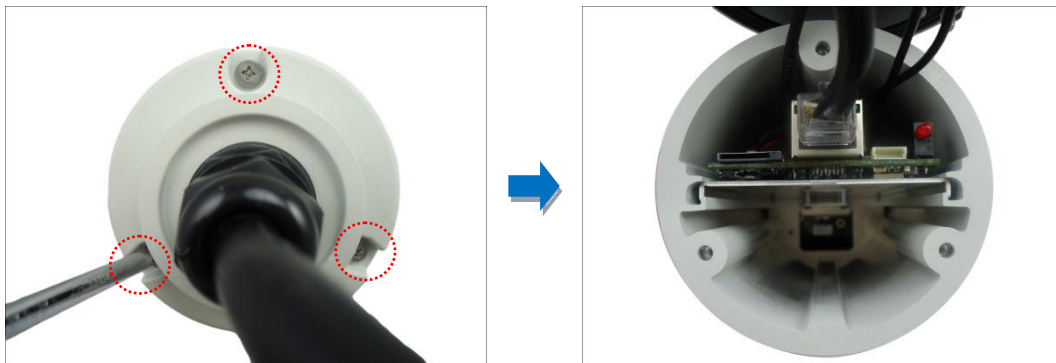

NOTE: Cables are connected inside the camera, do not abruptly pull the back cover.

How to Close the Back Cover

1. Align the screws and the guides of the back cover to the camera.

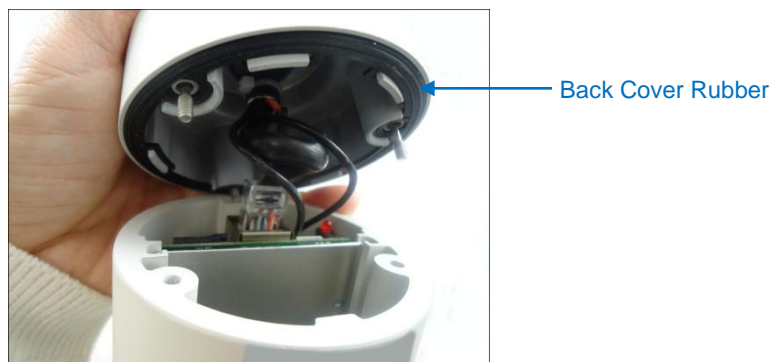

NOTE: Ensure that the rubber is properly aligned to the cover when closing the back cover.

2. Tighten the three (3) screws to secure the back cover.



3. Attach the three (3) screws to attach the integrated bracket to the camera.

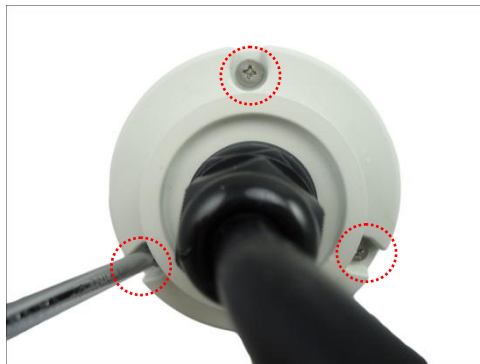

How to Insert the Memory Card

If there is a need to install a memory card for local storage recording, it is recommended to install the memory card first before mounting the camera.

Follow the procedures below:

1. Open the camera back cover. See [How to Open the Back Cover](#) on page 31.
2. Insert the memory card, with the metallic contacts facing down, into the slot until it clicks into place.

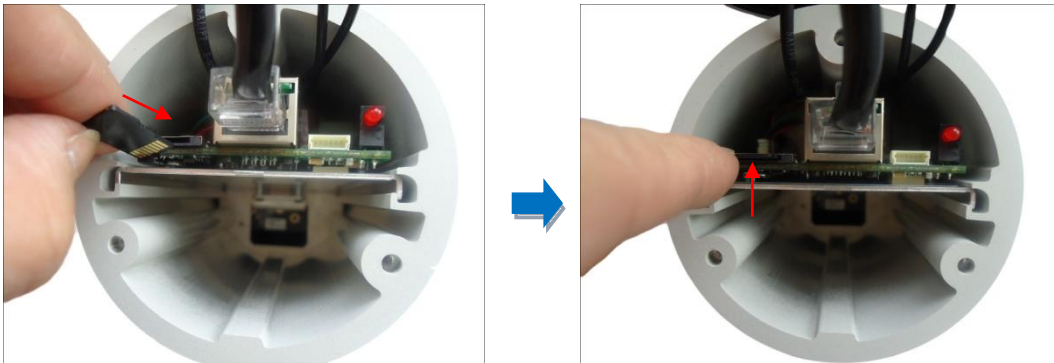

3. Close the back cover. See [How to Close the Back Cover](#) on page 31.

How to Remove the Memory Card

In case there is a need to remove the card, make sure to access the camera Web Configurator to safely “unmount” the card first (see the camera Firmware Manual for more information).

Once unmounted from the firmware, push the card to eject it from the slot.

How to Reset the Camera

The camera has a **Reset** button that can be used to restore the camera to its factory default settings when the need arises.

The **Reset** button is used for the following purposes:

- The administrator's password is forgotten and therefore the camera cannot be accessed
- In case of IP address, mask, or allow/deny filter related issues, resulting with the inability to modify these settings
- In case of connectivity issues or abnormal video quality

Do the following procedures to access the Reset button and restore the camera its default factory settings.

1. Open the camera back cover. See [How to Open the Back Cover](#) on page 31.
2. Press and hold the Reset button for at least 5 seconds or until the LED lights up.

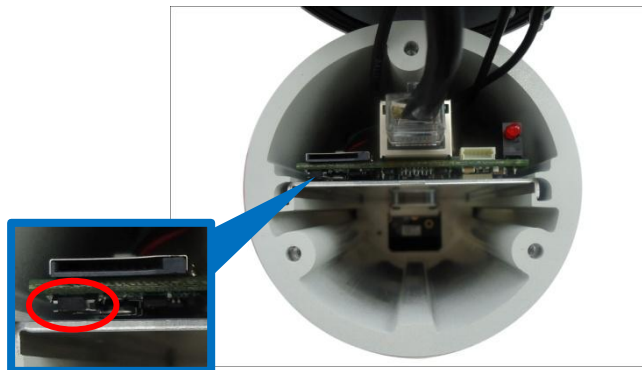

3. Attach the back cover. See [How to Close the Back Cover](#) on page 31.

Accessing the Camera

Configure the IP Addresses

In order to be able to communicate with the camera from your PC, both the camera and the PC have to be within the same network segment. In most cases, it means that they both should have very similar IP addresses, where only the last number of the IP address is different from each other. There are 2 different approaches to IP Address management in Local Area Networks – by DHCP Server or Manually.

Using DHCP Server to Assign IP Addresses

If you have connected the computer and the camera into the network that has a DHCP server running, then you do not need to configure the IP addresses at all – both the camera and the PC would request a unique IP address from DHCP server automatically. In such case, the camera will immediately be ready for the access from the PC. The user, however, might not know the IP address of the camera yet. It is necessary to know the IP address of the camera in order to be able to access it by using a Web browser.

The quickest way to discover the cameras in the network is to use the simplest network search, built in the Windows system – just by pressing the “Network” icon, all the cameras of the local area network will be discovered by Windows thanks to the UPnP function support of our cameras.

In the example below, we successfully found the camera model that we had just connected to the network.

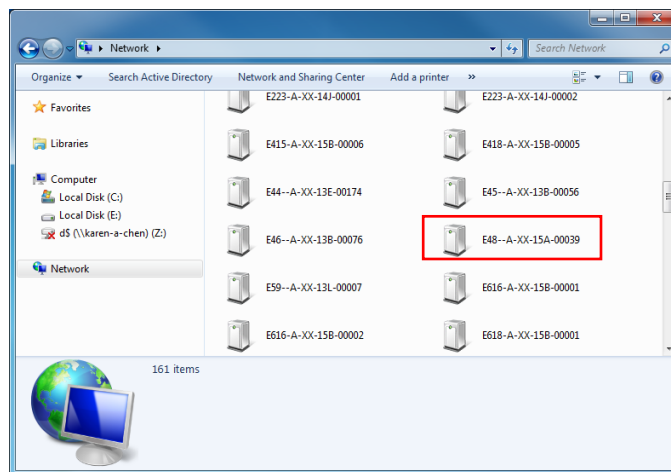

By double-clicking with the left mouse on the camera model, it is possible to automatically launch the default browser of the PC with the IP address of the target camera filled in the address bar of the browser already.

If you work with our cameras regularly, then **there is even a better way to discover the cameras in the network** – by using **IP Utility**. The IP Utility is a light software tool that can not only discover the cameras, but also list lots of valuable information, such as IP and MAC addresses, serial numbers, firmware versions, etc, and allows quick configuration of multiple devices at the same time.

The IP Utility can be downloaded for free from http://www.acti.com/IP_Utility

With just one click, you can launch the IP Utility and there will be an instant report as follows:

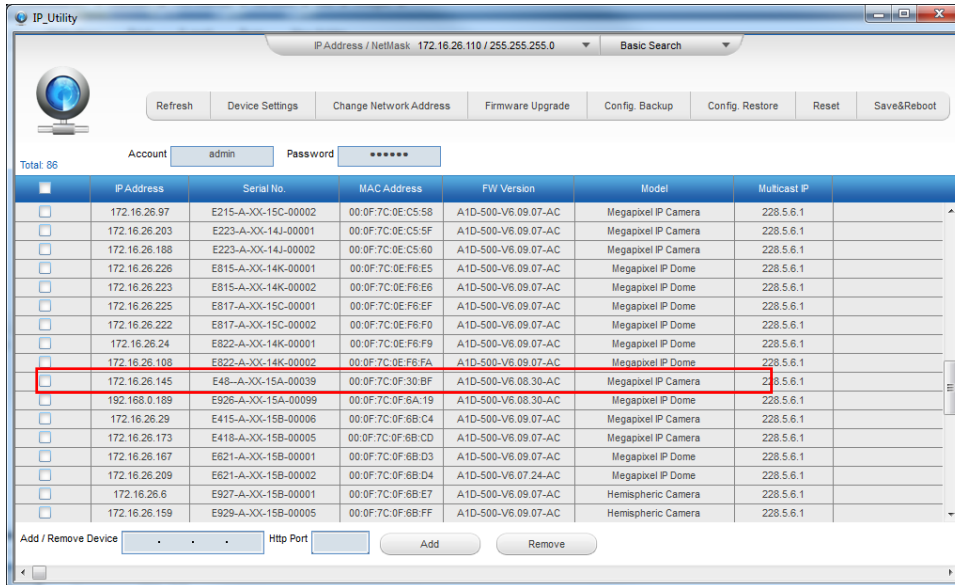

You can quickly see the camera model in the list. Click on the IP address to automatically launch the default browser of the PC with the IP address of the target camera filled in the address bar of the browser already.

Using the Default Camera IP Address

If there is no DHCP server in the given network, the user may have to assign the IP addresses to both PC and camera manually to make sure they are in the same network segment.

When the camera is plugged into network and it does not detect any DHCP services, it will automatically assign itself a default IP:

192.168.0.100

Whereas the default port number would be **80**. In order to access that camera, the IP address of the PC has to be configured to match the network segment of the camera.

Manually adjust the IP address of the PC:

In the following example, based on Windows 7, we will configure the IP address to **192.168.0.99** and set Subnet Mask to **255.255.255.0** by using the steps below:

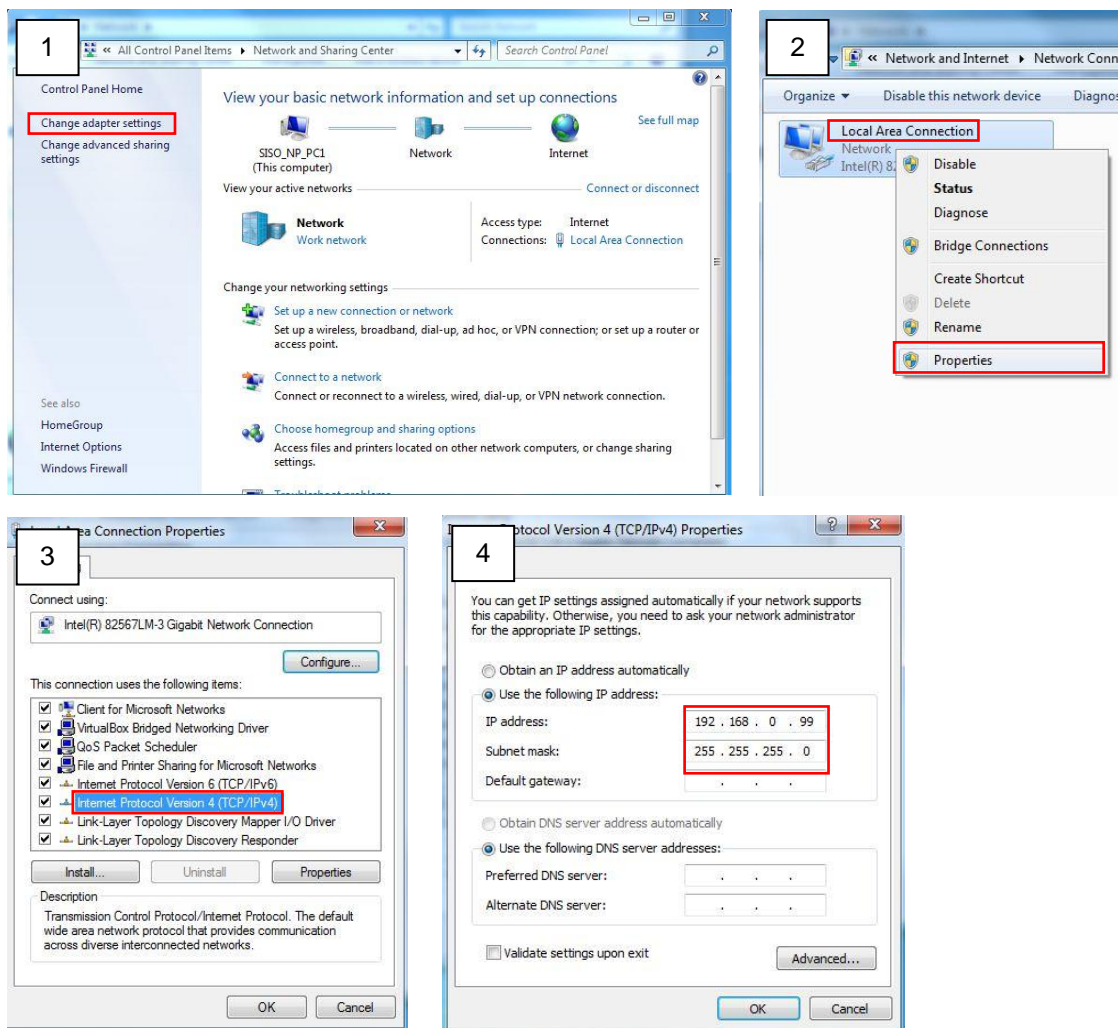

Manually adjust the IP addresses of multiple cameras:

If there are more than 1 camera to be used in the same local area network and there is no DHCP server to assign unique IP addresses to each of them, all of the cameras would then have the initial IP address of **192.168.0.100**, which is not a proper situation for network devices – all the IP addresses have to be different from each other. The easiest way to assign cameras the IP addresses is by using **IP Utility**:

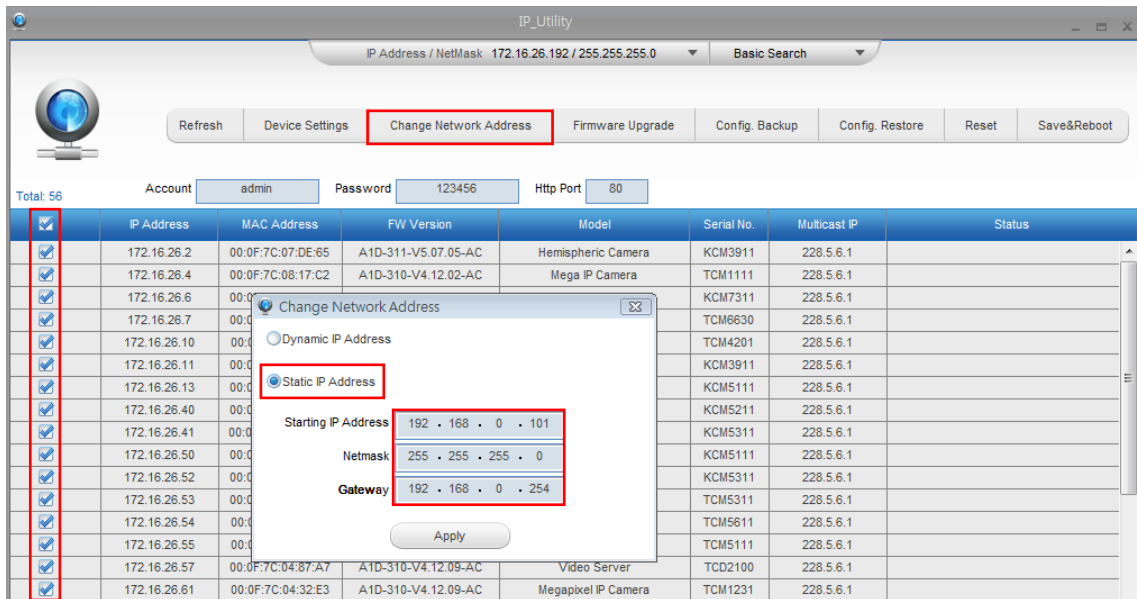

With the procedure shown above, all the cameras will have unique IP addresses, starting from 192.168.0.101. In case there are 20 cameras selected, the last one of the cameras would have the IP 192.168.0.120.

Later, by pressing the “Refresh” button of the IP Utility, you will be able to see the list of cameras with their new IP addresses.



Please note that it is also possible to change the IP addresses manually by using the Web browser. In such case, please plug in only one camera at a time, and change its IP address by using the Web browser before plugging in the next one. This way, the Web browser will not be confused about two devices having the same IP address at the same time.

Access the Camera

Now that the camera and the PC are both having their unique IP addresses and are under the same network segment, it is possible to use the Web browser of the PC to access the camera.

You can use **any of the browsers** to access the camera, however, the full functionality is provided only for **Microsoft Internet Explorer**.

The browser functionality comparison:

Functionality	Internet Explorer	Other browsers
Live Video	Yes	Yes*
Live Video Area Resizable	Yes	No
PTZ Control	Yes	Yes
Capture the snapshot	Yes	Yes
Video overlay based configuration (Motion Detection regions, Privacy Mask regions)	Yes	No
All the other configurations	Yes	Yes

* When using non-Internet Explorer browsers, free third-party software plug-ins must be installed to the PC first to be able to get the live video feed from the camera:

Browser	Required Plug-In
Safari	QuickTime (http://www.apple.com/quicktime/download/)
Other non-Internet Explorer browsers	Basic VLC Media Player (http://www.videolan.org)

***Disclaimer Notice:** The camera manufacturer does not guarantee the compatibility of its cameras with QuickTime or VLC Player – since these are third party softwares. The third parties have the right to modify their utility any time which might affect the compatibility. In such cases, please use Internet Explorer browser instead.*

When using Internet Explorer browser, the ActiveX control for video stream management will be downloaded from the camera directly – the user just has to accept the use of such control when prompted so. No other third party utilities are required to be installed in such case.

The following examples in this manual are based on Internet Explorer browser in order to cover all functions of the camera.

Assuming that the camera's IP address is **192.168.0.100**, you can access it by opening the Web browser and typing the following address into Web browser's address bar:

http://192.168.0.100

Upon successful connection to the camera, the user interface called **Web Configurator** would appear together with the login page. The HTTP port number was not added behind the IP address since the default HTTP port of the camera is 80, which can be omitted from the address for convenience.

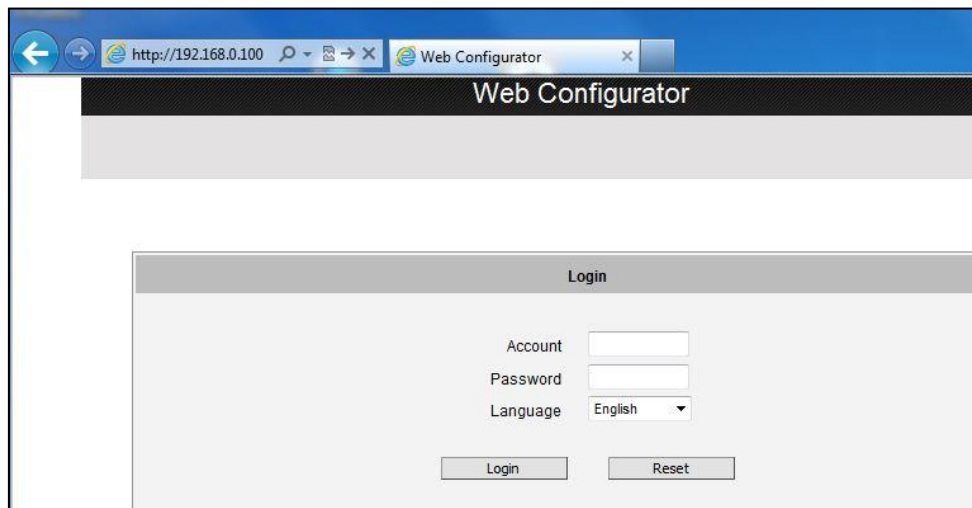

Before logging in, you need to know the factory default Account and Password of the camera.

Account: **Admin**

Password: **123456**



Copyright © 2015, ACTi Corporation All Rights Reserved

7F, No. 1, Alley 20, Lane 407, Sec. 2, Ti-Ding Blvd., Neihu District, Taipei, Taiwan 114, R.O.C.

TEL : +886-2-2656-2588 FAX : +886-2-2656-2599

Email: sales@acti.com