



Indoor Dome Series Hardware Manual

D61A, D65A

E62A, E63A, E65A, E66A

E68, E69

2014/08/22



ACTi
Connecting Vision

Table of Contents

Precautions 4

Safety Instructions	6
---------------------------	---

Introduction 7

The List of Models	7
Package Contents.....	8
Physical Description	9
Mounting Options	11
Other Mounting Accessories	13

Before Installation..... 14

How to Connect DI/Do Devices.....	14
How to Connect Audio Devices	17

Installing the Camera on a Surface 18

Step 1: Drill the Holes.....	18
Step 2: Open the Dome Cover	19
Step 3: Install the Camera to the Surface	20
Step 4: Connect the Cable	21
Step 5: Access the Camera Live View.....	22
Step 6: Adjust the Viewing Angle and Focus	22
Step 7: Close the Dome Cover.....	22

Other Adjustments and Accessories 24

How to Adjust the Camera Viewing Angle and Focus	24
D61A, E66A Camera Models	24
D65A, E62A, E63A, E65A, E68, E69 Camera Models	26
How to Replace the Dome Cover	27
How to Use a Memory Card	30
How to Insert the Memory Card	30
How to Remove the Memory Card	30

Accessing the Camera 31

Configure the IP Addresses	31
Access the Camera.....	35

Precautions

Read these instructions

You should read all the safety and operating instructions before using this product.

Heed all warnings

You must adhere to all the warnings on the product and in the instruction manual. Failure to follow the safety instruction given may directly endanger people, cause damage to the system or to other equipment.

Servicing

Do not attempt to service this video device yourself as opening or removing covers may expose you to dangerous voltage or other hazards. Refer all servicing to qualified service personnel.

Trademarks

All names used in this manual are probably registered trademarks of respective companies.

Liability

Every reasonable care has been taken during the writing of this manual. Please inform your local office if you find any inaccuracies or omissions. We cannot be held responsible for any typographical or technical errors and reserve the right to make changes to the product and manuals without prior notice.

Federal Communications Commission Statement



This equipment has been tested and found to comply with the limits for a class B digital device, pursuant to Part 15 of the FCC Rules. These limits are designed to provide reasonable protection against harmful interference in a residential installation. This equipment generates, uses, and can radiate radio frequency energy and, if not installed and used in accordance with the instructions, may cause harmful interference to radio communications. However, there is no guarantee that interference will not occur in a particular installation. If this equipment does cause harmful interference to radio or television reception, which can be determined by turning the equipment off and on, the user is encouraged to try to correct the interference by one or more of the following measures:

- Reorient or relocate the receiving antenna.
- Increase the separation between the equipment and receiver.
- Connect the equipment into an outlet on a circuit different from that to which the receiver is connected.
- Consult the dealer or an experienced radio/TV technician for help.

Warning: Changes or modifications to the equipment that are not expressly approved by the responsible party for compliance could void the user's authority to operate the equipment.

European Community Compliance Statement



This product has been tested and found to comply with the limits for Class B Information Technology Equipment according to European Standard EN 55022 and EN 55024. In a domestic environment, this product may cause radio interference in which cause the user may be required to take adequate measures.

Safety Instructions

Cleaning

Disconnect this video product from the power supply before cleaning.

Attachments

Do not use attachments not recommended by the video product manufacturer as they may cause hazards.

Do not use accessories not recommended by the manufacturer

Only install this device in a dry place protected from weather

Servicing

Do not attempt to service this video product yourself. Refer all servicing to qualified service personnel.

Damage Requiring service

Disconnect this video product from the power supply immediately and refer servicing to qualified service personnel under the following conditions.

- 1) When the power-supply cord or plug is damaged
- 2) If liquid has been spilled, or objects have fallen into the video product.
- 3) If the inner parts of video product have been directly exposed to rain or water.
- 4) If the video product does not operate normally by following the operating Instructions in this manual. Adjust only those controls that are covered by the instruction manual, as an improper adjustment of other controls may result in damage, and will often require extensive work by a qualified technician to restore the video product to its normal operation.









Safety Check

Upon completion of any service or repairs to this video product, ask the service technician to perform safety checks to determine if the video product is in proper operating condition.

Introduction





The List of Models

This hardware manual contains the following models:

D61A		1.3MP Indoor Dome with SLLS, Vari-focal lens
D65A		3MP Indoor Dome with D/N, Adaptive IR, Vari-focal lens
E62A		3MP Indoor Dome with D/N, Adaptive IR, Basic WDR, Vari-focal lens
E63A		5MP Indoor Dome with D/N, Adaptive IR, Basic WDR, Vari-focal lens
E65A		3MP Indoor Dome with D/N, Adaptive IR, Superior WDR, Vari-focal lens
E66A		1.3MP Indoor Dome with Basic WDR, SLLS, Vari-focal lens
E68		1.3MP Indoor Dome with D/N, Adaptive IR, Basic WDR, SLLS, Vari-focal lens
E69		2MP Indoor Dome with D/N, Adaptive IR, Basic WDR, SLLS, Vari-focal lens

From the installation perspective these models are very similar; therefore you can use one manual for all of them.

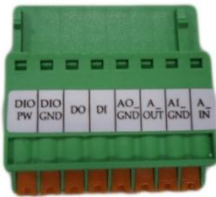
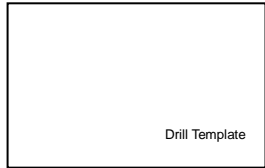
Package Contents

<p>Camera (D61A, E66A)</p>	<p>Camera</p>	<p>Mounting Screw Kit</p>
	<p style="text-align: center; color: white; background-color: red; padding: 5px;">or</p> 	
<p>Hexagon Screwdriver</p>	<p>Terminal Block (for Audio and DI/DO)</p>	<p>Drill Template</p>
		 <p style="text-align: center;">Drill Template</p>
<p>Quick Installation Guide</p>	<p>Warranty Card</p>	
		

Physical Description

D61A, E66A

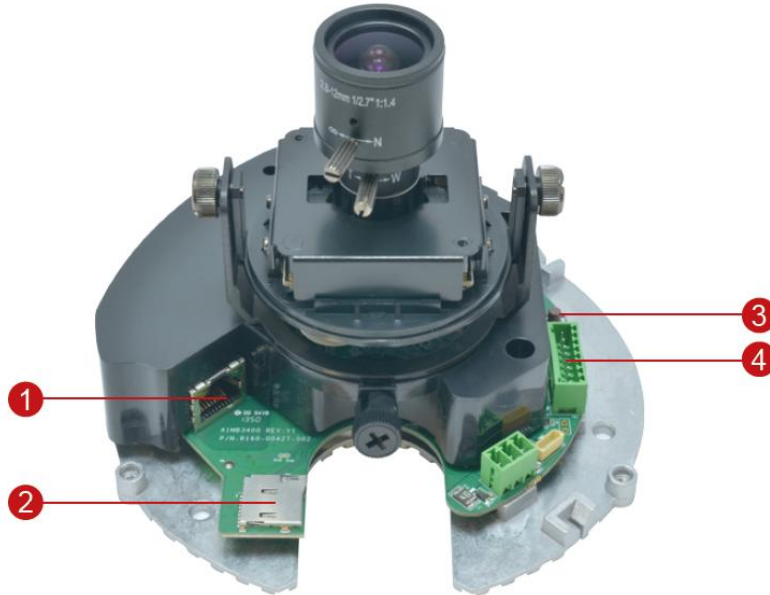

D65A, E62A, E63A, E65A, E66A, E68, E69



NOTE: Actual camera may slightly differ.

1) Ethernet Port

Connects to a network using an Ethernet cable.

2) Memory Card Slot

Insert a memory card into this slot for local recording purposes. See [How to Use a Memory Card](#) on page 30 for more information.

NOTE: Supports microSDHC and microSDXC cards.

3) Reset Button

The purpose of reset button is to restore the factory default settings of the camera, including the administrator's password.

The reset button can be used for following purposes:

The administrator's password has been forgotten and therefore the camera cannot be accessed.

1. In case of IP address, mask, or allow/deny filter related issues, resulting with inability to modify these settings.
2. In case of connectivity issues or abnormal video quality.

How to do the reset properly?









Press and hold the reset button for 5 seconds.





4) Digital Input / Output (DI/DO) and Audio Input / Output

This connector connects to digital input or output devices, such as an alarm trigger, panic button, etc., as well as audio input and output devices, such as microphones and speakers. Digital Input (DI) and Digital Output (DO) devices are used in applications like motion detection, event triggering, alarm notifications, etc. See [How to Connect DI/Do Devices](#) on page 14 and [How to Connect Audio Devices](#) on page 17 for more information.

Mounting Options

There are several mounting options that you can use to install the camera. Select the most suitable solution for your installation environment. Below are some examples only.

Mount Types	Accessories
Surface Mount	Suitable when mounting the camera directly on walls or ceilings without extra accessories. See Installing the Camera on a Surface on page 18 for mounting instructions.
Flush Mount	Suitable when mounting the camera discretely above dropped ceilings wherein only the dome cover will be visible underneath the ceiling.
	PMAX-1003 
Gang Box Converter	Suitable for locations which require the use of gang boxes. The Gang Box Converter can be attached to a “two-gang” or 4” square gang box. Then, the camera can be installed on the Gang Box Converter. All cables are hidden inside the gang box.
	PMAX-0803 
Pendant Mount	Suitable when mounting the camera on hard and high ceilings.
	PMAX-0101 PMAX-0103 (Straight Tube with Bracket)   
	PMAX-0101 PMAX-0102 (Straight Tube)   

Mount Types	Accessories
Straight Wall Mount	Suitable when mounting the camera on straight walls.
	PMAX-0313 
Vertical Pole Mount	Suitable when mounting the camera on vertical poles.
	PMAX-0313 PMAX-0503 
Horizontal Pole Mount	Suitable when mounting the camera on horizontal poles.
	PMAX-0101 PMAX-0102 PMAX-0503 
Corner Mount	Suitable when mounting the camera on a corner wall.
	PMAX-0313 PMAX-0402 

NOTE: More options are available in our website (<http://www.acti.com/mountingselector>).

Other Mounting Accessories

Accessories

PMAX-0104 (Extension Tube)



NOTE:

- For more information about the mounting solutions and accessories, please check the *Mounting Accessory Selector* in our website (<http://www.acti.com/mountingselector>).
- The above mounting accessories are not included in the package. Contact your sales agents to purchase.

Before Installation

This section describes the procedures in preparing the external devices that you can connect to the camera. Depending on your surveillance needs, you may connect digital input (DI) or digital output (DO) or audio input / output devices to your camera. The camera comes with one (1) terminal block for both digital and audio input / output devices. The use of these devices, however, is optional.

How to Connect DI/Do Devices

Digital Input (DI) devices can be used to notify the camera about an activity in the camera site. DI can be triggers of events. For example, you can connect a “panic button” to the camera; as such when the panic button is pressed, the alarm signal will be sent through the camera. Other common DI device applications are emergency button, smoke detector, passive infrared sensor, etc.

Digital Output (DO) devices are external devices that are activated by the camera upon an event inside the camera. For example, you can connect an “alarm horn” to the camera; as such when an event occurs inside the camera (e.g. detected intruder), the alarm horn will sound. Other common DO device applications are motion-triggered lights, electric fence, magnetic door locks, etc.

Press and hold the orange tab as you insert the wire through the pin slot, then release the orange tab to secure the wire.

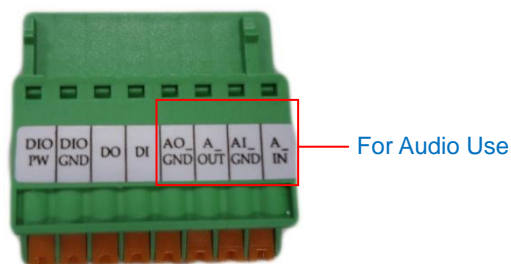

To connect digital input / output devices (DI/DO), map the pins to one of the pin combinations below:

Device	Pin	Mapping Instructions
Digital Output (DO)	DIO PW	Connect the wires of the output device to DIO PW and DO .
	DO	
Digital Input (DI)	DIO GND	Connect the wires of the input device to DIO GND and DI .
	DI	

The table below shows the DI/DO connection specifications:

Device			
DI	Connection design		TTL - compatible logic levels
	Voltage	To trigger (low)	Logic level 0: 0V ~ 0.4V
		Normal (high)	Logic level 1: 3.1V ~ 30V
	Current		10mA ~ 100mA
DO	Connection design		Transistor (Open Collector)
	Voltage & Current		< 24V DC, < 50mA

Typical Connection

Based on these specifications, if the DI device has a voltage of 0V ~ 30V or the DO device has a voltage of < 24V (< 50mA), then the camera can supply internal power to these devices and there is no need to connect the DI/DO device to an external power source.

In this case, wire the connection as below. Use the **DIO GND** and **DI** pins to connect a DI device and use the **DIO PW** and **DO** pins to connect a DO device. See wiring scheme below:

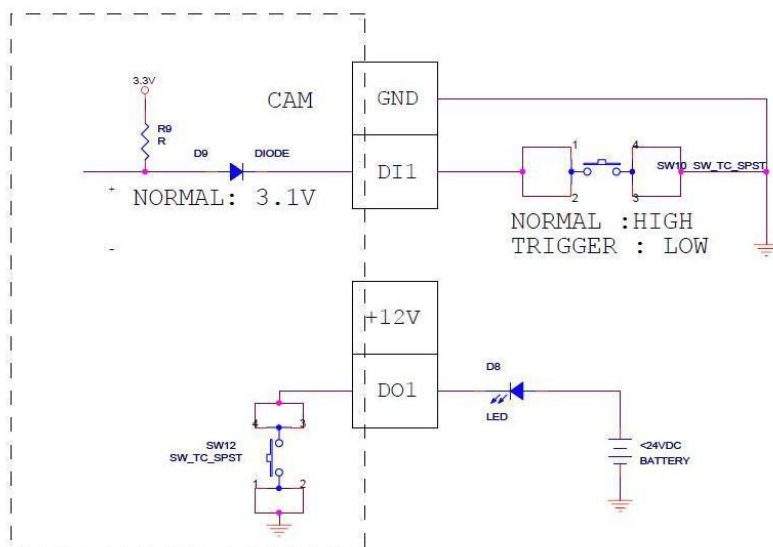

High Voltage DO Device Connection

Even though the camera provides 12V power, this may not be enough for some high voltage DO devices, such as a ceiling light or a motor that opens or closes a gate. In this case, there is a need to connect an external relay. See wiring scheme below:

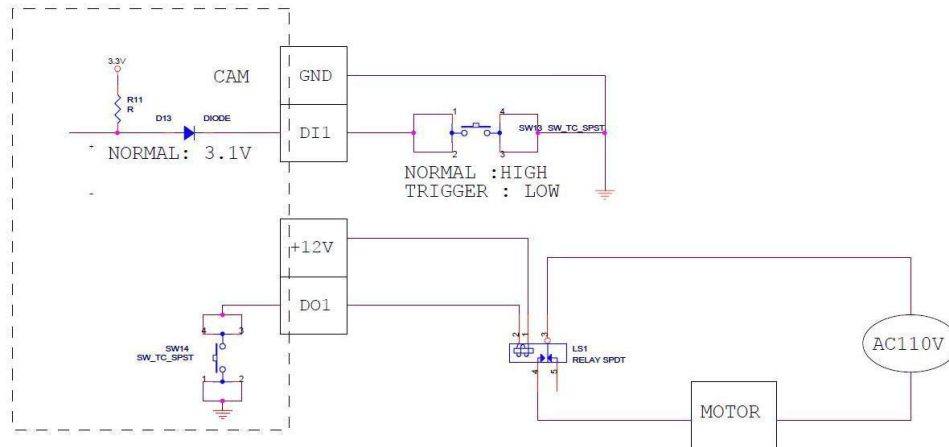

Note that when choosing an appropriate relay, please refer to its specifications and make sure they match the above design. The triggering circuit voltage has to be around 12V DC and the switch-controlled circuit voltage has to match the external power supply (e.g. 110V AC or 220V AC).

The illustration below is a graphic example of connecting a relay to a high voltage DO device.

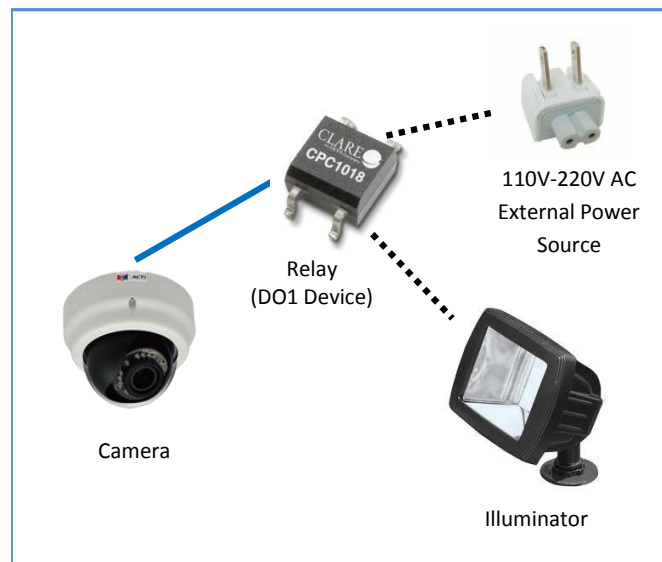

NOTE: For more information on DI/DO connections, please refer to the Knowledge Base article [All about Digital Input and Digital Output](http://www.acti.com/kb/detail.asp?KB_ID=KB20091230001) downloadable from the link below (http://www.acti.com/kb/detail.asp?KB_ID=KB20091230001).

How to Connect Audio Devices

Audio input / output devices, such as an active microphone or speaker can be connected to the camera using the supplied terminal block.

Press and hold the orange tab as you insert the wire through the pin slot, then release the orange tab to secure the wire.

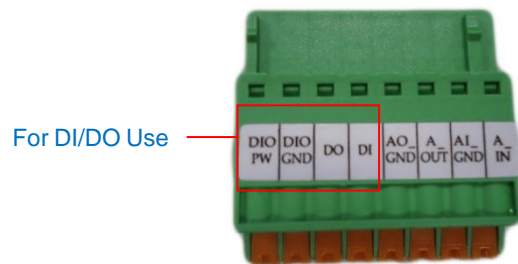

To connect audio devices, map the pins to one of the pin combinations below:

Device	Pin	Mapping Instructions
Audio Output (AO)	AO_GND	Connect the wires of the audio output device to AO_GND and A_OUT .
	A_OUT	
Audio Input (A1)	AI_GND	Connect the wires of the audio input device to AI_GND and A_IN .
	A_IN	

NOTE: For more information about AUDIO in connections, please refer to the Knowledge Base article [How to Use Audio-in of ACTi Cameras](http://www.acti.com/support/KnowledgeBase/outside/detail.asp?KB_ID=KB20100114003), downloadable from the link below (http://www.acti.com/support/KnowledgeBase/outside/detail.asp?KB_ID=KB20100114003).

Installing the Camera on a Surface

This section describes the procedures in installing the camera on a flat surface such as a hard or dropped ceiling and straight or tilted walls. Before installation, make sure the wall or the ceiling can bear more than the weight of the camera.

NOTE: The camera images on the succeeding pages may slightly vary from the actual camera.

Step 1: Drill the Holes

Before drilling the holes on the ceiling or wall, note the direction of the connectors side of the camera, which is also the opposite side of the camera logo. This influences the camera placement and where you should drill the hole where the cables will pass through or how the cables will go along the ceiling or wall.

1. Use the supplied drill template to mark the screw holes on the surface according to the preferred orientation.
2. Determine how the cables will be routed: ***pass through the surface*** or ***along the surface***.
 - ***If the cables will pass through the surface***, drill the cable hole and the three (3) screw holes on the surface.

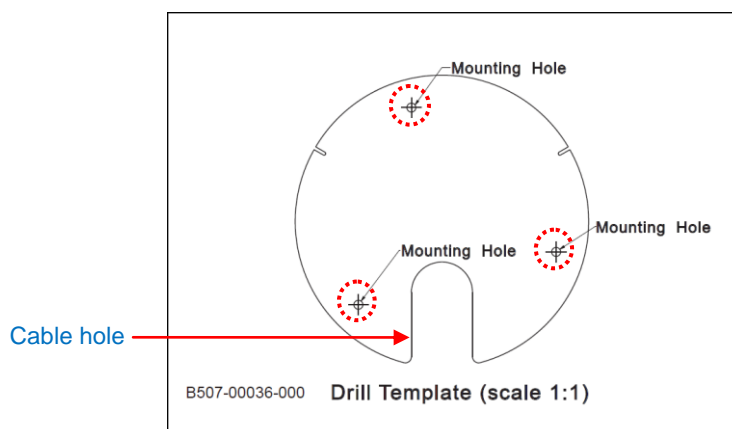

- ***If the cables will be routed along the surface***, just drill the three (3) screw holes on the surface.
3. Insert the plastic plugs into the screw holes.

Step 2: Open the Dome Cover

NOTE: To avoid scratches or leaving fingerprints on the dome cover, it is recommended to retain the plastic covering the dome cover until the camera is completely installed.

1. With the bundled hex screwdriver, loosen the three (3) screws securing the dome cover.



2. Lift to remove the dome cover.



3. For **D61A, E66A**, remove the styrofoam covering the camera lens.



4. ***If the cables will be routed along the ceiling or wall***, remove the cable tab from the dome cover.



5. ***If the cables will pass through the ceiling or wall***, route and pull the cables through the hole on the surface.

Step 3: Install the Camera to the Surface

1. If necessary, insert a memory card, with the metallic contacts facing down, into the card slot of the camera.



2. Align the camera screw holes and the cable hole (if necessary) to the holes on the surface and attach the three (3) supplied screws to secure the camera.



⚠ CAUTION: *When using electric screwdrivers*, be careful not to touch the camera components while attaching the screws. Since electric screwdrivers vary in sizes, speed, and force, they may bruise and damage the camera components.

DISCLAIMER: ACTi will not be responsible for camera damage caused by improper installations or the misuse of equipment for installation.

Step 4: Connect the Cable

1. Connect the network cable to the Ethernet port of the camera. If necessary, connect other cable connectors (optional), like audio input/output and DI/DO to the connector on the camera. See *Before Installation* on page 14.

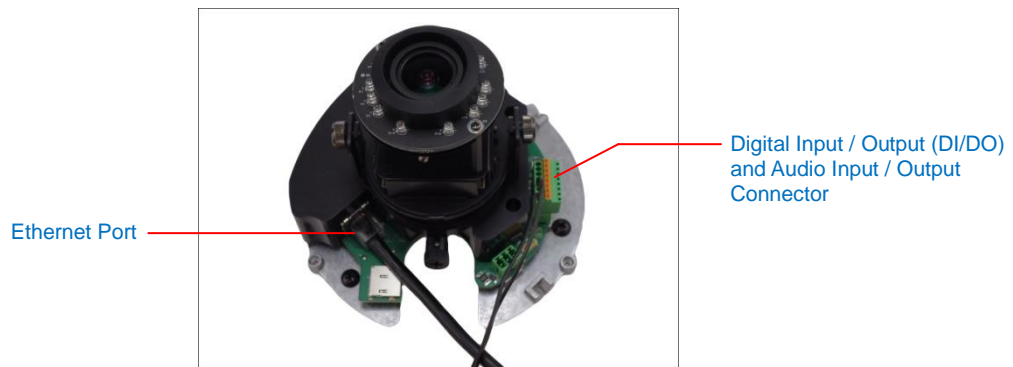

2. Connect the other end of the network cable to a switch or injector. Then, connect the switch or injector to a network, PC and a power source. See Power-over-Ethernet (PoE) connection example below.

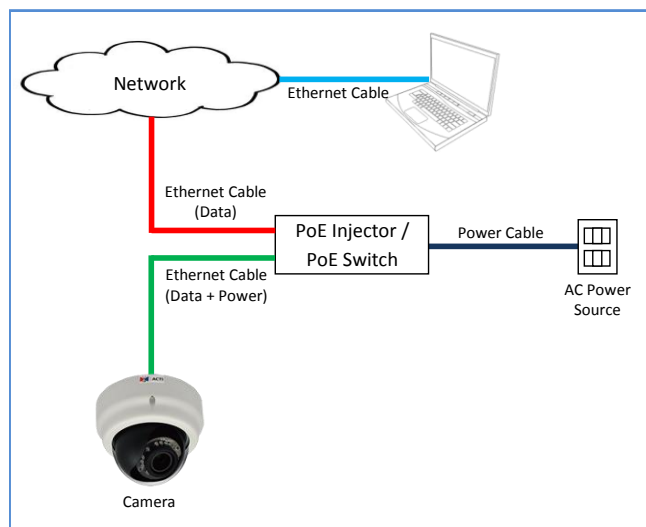

Step 5: Access the Camera Live View

See [Accessing the Camera](#) on page 31 for more information on how to access the Live View of the camera.

Step 6: Adjust the Viewing Angle and Focus

Based on the camera live view, adjust the viewing angle, orientation and focus of the camera. Adjustments vary depending on model, see [How to Adjust the Camera Viewing Angle and Focus](#) on page 24 for more information.

Step 7: Close the Dome Cover

1. Turn the dome cover shroud to align to the direction of the lens.



2. Align the screws with the screw holes of the camera. **Note that if the cables are routed along the ceiling or wall,** route the cable to pass through the cable hole on the dome cover.



3. Tighten the three (3) screws to attach the dome cover to the camera body.



4. Remove the plastic covering the dome cover.



Final installation should look similar to the illustration below.



Other Adjustments and Accessories

How to Adjust the Camera Viewing Angle and Focus

This section describes procedures in adjusting the pan direction of the camera, as well as the viewing angle and focus, if necessary since the camera comes with the focus and viewing angle already pre-fixed.

D61A, E66A Camera Models

Camera Parts Overview

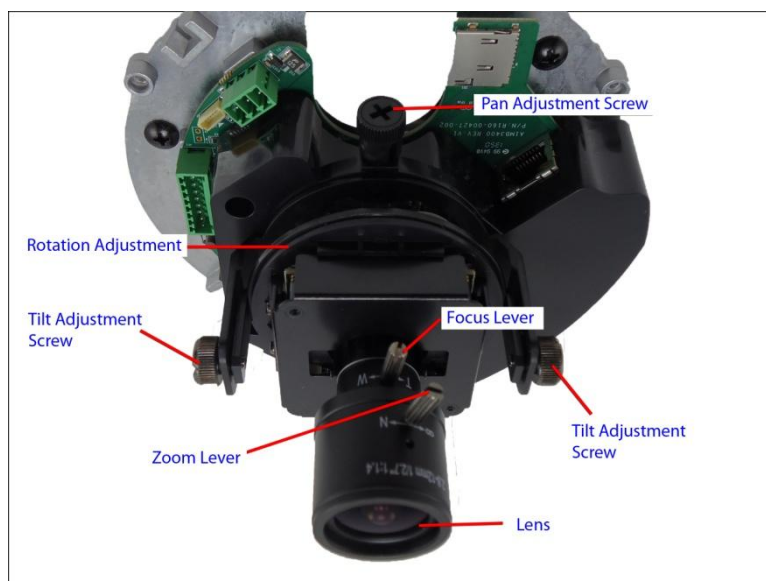

Adjustment Procedures

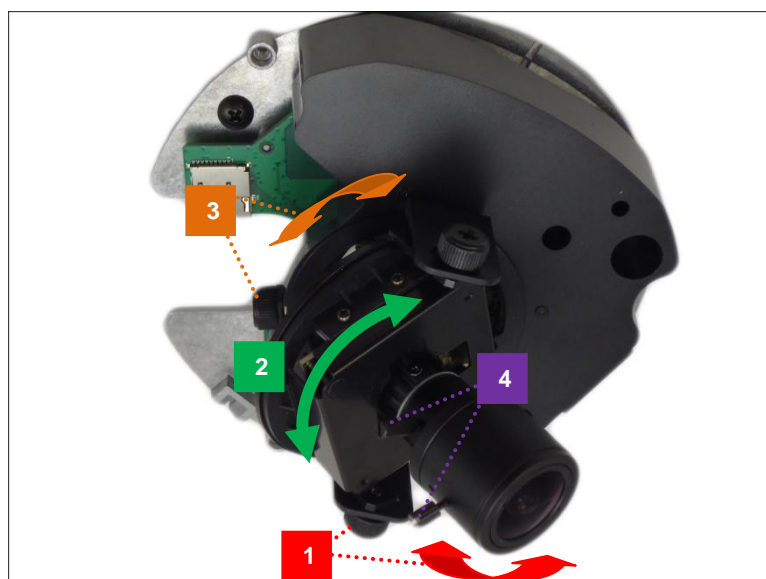

1. Loosen the tilt adjustment screws, adjust the tilt, and then tighten back the screws to fix the tilt position.
2. Turn the rotation adjustment to rotate the viewing orientation.
3. Loosen the pan adjustment screw, move the pan direction, and then tighten back the screw to fix the pan position.
4. If the focus needs to be adjusted, turn the zoom and focus lever counter-clockwise to loosen them. Then move the zoom and focus levers left or right to adjust the focus and the viewing angle.

D65A, E62A, E63A, E65A, E68, E69 Camera Models

Camera Parts Overview

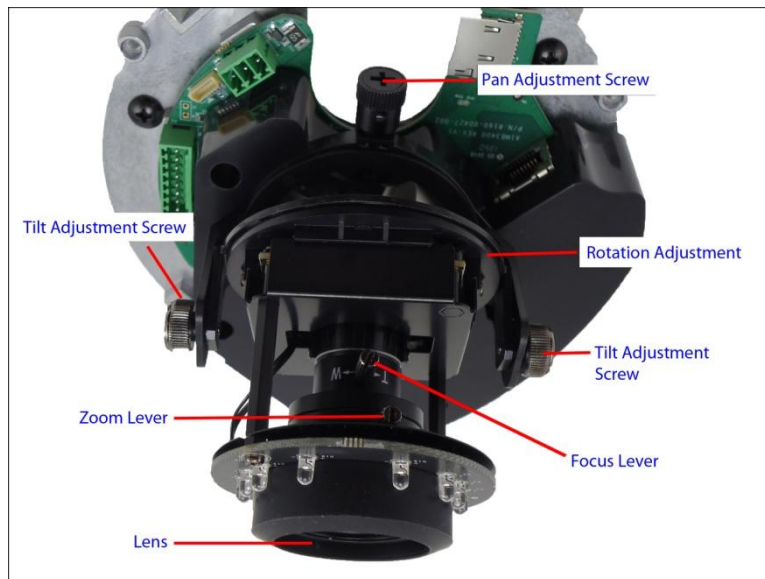

Adjustment Procedures

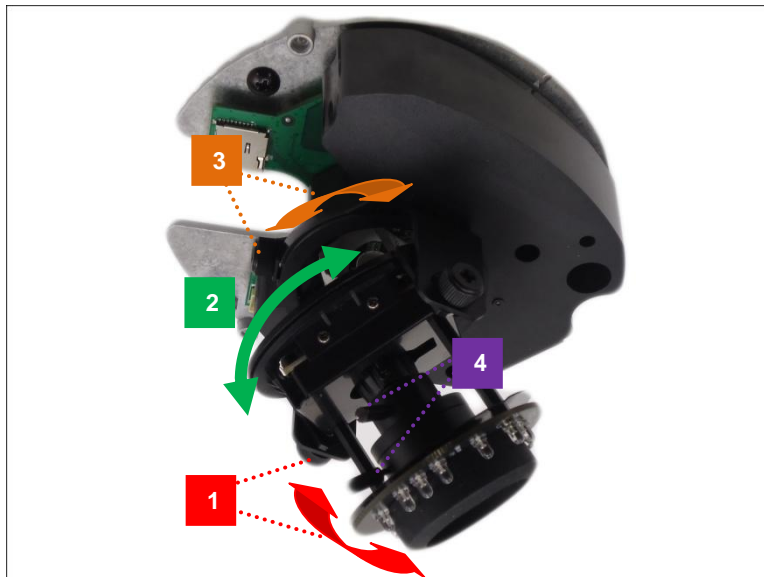

1. Loosen the tilt adjustment screws, adjust the tilt, and then tighten back the screws to fix the tilt position.
2. Turn the rotation adjustment to rotate the viewing orientation.
3. Loosen the pan adjustment screw, move the pan direction, and then tighten back the screw to fix the pan position.
4. If the focus needs to be adjusted, turn the zoom and focus lever counter-clockwise to loosen them. Then move the zoom and focus levers left or right to adjust the focus and the viewing angle.

How to Replace the Dome Cover

For more discrete surveillance needs, the bundled dome cover can be replaced with a smoke, vandal proof cover available for purchase. To replace the dome cover, do the following:

1. Loosen the three (3) screws to open the dome cover.



2. Remove the three (3) screws to detach the bracket.



3. Remove the bracket and dome cover from the cover housing.



4. Remove the shroud from the dome cover.



5. Place the shroud on the replacement dome cover.



6. Insert the replacement dome cover into the cover housing.



7. Align and attach the three (3) screws to secure the bracket to the cover housing.

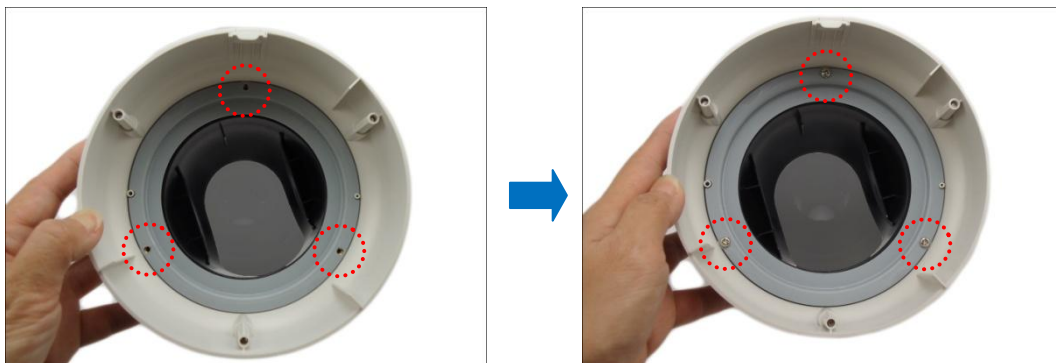

- 8. Attach the dome cover to the camera by tightening the three (3) screws. Final installation should look similar to the illustration below.

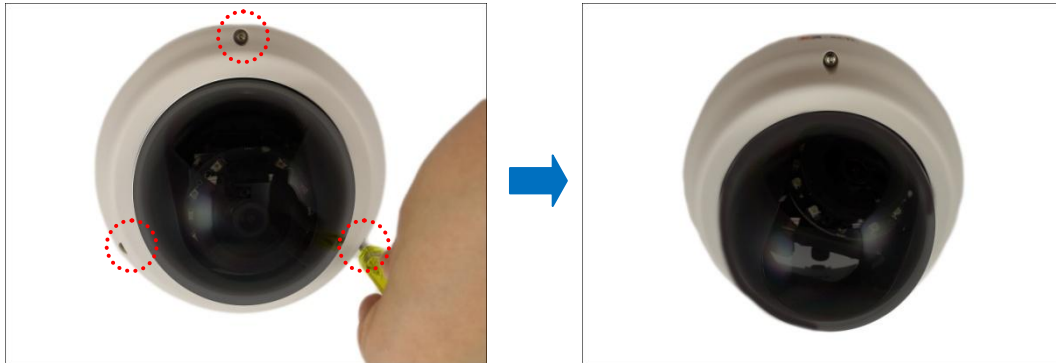

How to Use a Memory Card

The camera supports local video recording or saving of snapshots to a memory card.

NOTE: Supports microSDHC and microSDXC cards.

How to Insert the Memory Card

Insert a memory card into the card slot with the metallic contacts facing down the camera. Push the card until it clicks into place.



How to Remove the Memory Card

In case there is a need to remove the card, make sure to access the camera Web Configurator to safely “unmount” the card first (see the camera Firmware manual for more information). Once unmounted from the firmware, push the card to eject it from the slot.

Accessing the Camera

Configure the IP Addresses

In order to be able to communicate with the camera from your PC, both the camera and the PC have to be within the same network segment. In most cases, it means that they both should have very similar IP addresses, where only the last number of the IP address is different from each other. There are 2 different approaches to IP Address management in Local Area Networks – by DHCP Server or Manually.

Using DHCP server to assign IP addresses:

If you have connected the computer and the camera into the network that has a DHCP server running, then you do not need to configure the IP addresses at all – both the camera and the PC would request a unique IP address from DHCP server automatically. In such case, the camera will immediately be ready for the access from the PC. The user, however, might not know the IP address of the camera yet. It is necessary to know the IP address of the camera in order to be able to access it by using a Web browser.

The quickest way to discover the cameras in the network is to use the simplest network search, built in the Windows system – just by pressing the “Network” icon, all the cameras of the local area network will be discovered by Windows thanks to the UPnP function support of our cameras.

In the example below, we successfully found the camera model that had just connected to the network.

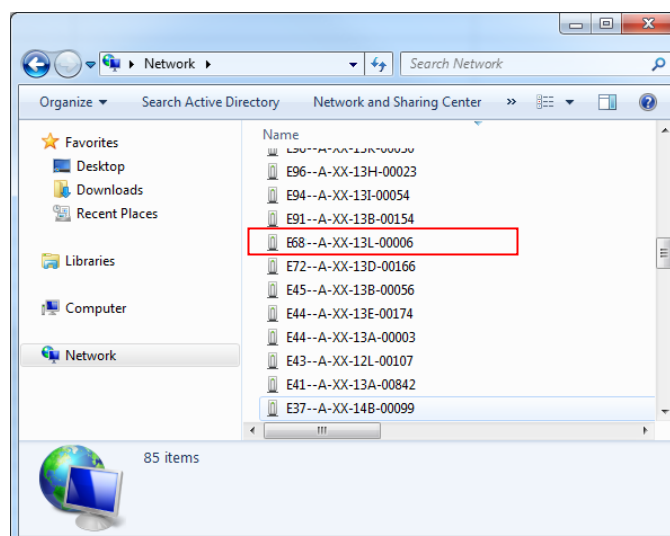

Double-click on the camera model name, the default browser of the PC is automatically launched and the IP address of the target camera is already filled in the address bar of the browser.

If you work with our cameras regularly, then **there is even a better way to discover the cameras in the network** – by using **IP Utility**. The IP Utility is a light software tool that can not only discover the cameras, but also list lots of valuable information, such as IP and MAC addresses, serial numbers, firmware versions, etc, and allows quick configuration of multiple devices at the same time.

The IP Utility can be downloaded for free from http://www.acti.com/IP_Utility

With just one click, you can launch the IP Utility and there will be an instant report as follows:

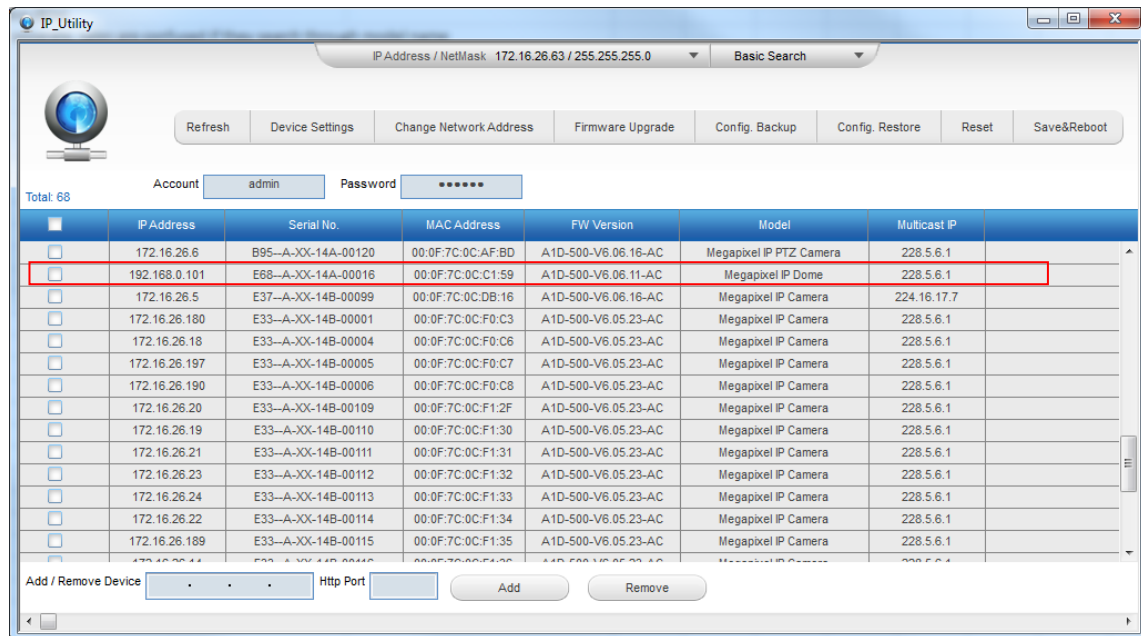

You can quickly notice the camera model in the list. Click on the IP address to automatically launch the default browser of the PC with the IP address of the target camera filled in the address bar of the browser already.

Use the default IP address of a camera:

If there is no DHCP server in the given network, the user may have to assign the IP addresses to both PC and camera manually to make sure they are in the same network segment.

When the camera is plugged into network and it does not detect any DHCP services, it will automatically assign itself a default IP:

192.168.0.100

Whereas the default port number would be **80**. In order to access that camera, the IP address of the PC has to be configured to match the network segment of the camera.

Manually adjust the IP address of the PC:

In the following example, based on Windows 7, we will configure the IP address to **192.168.0.99** and set Subnet Mask to **255.255.255.0** by using the steps below:

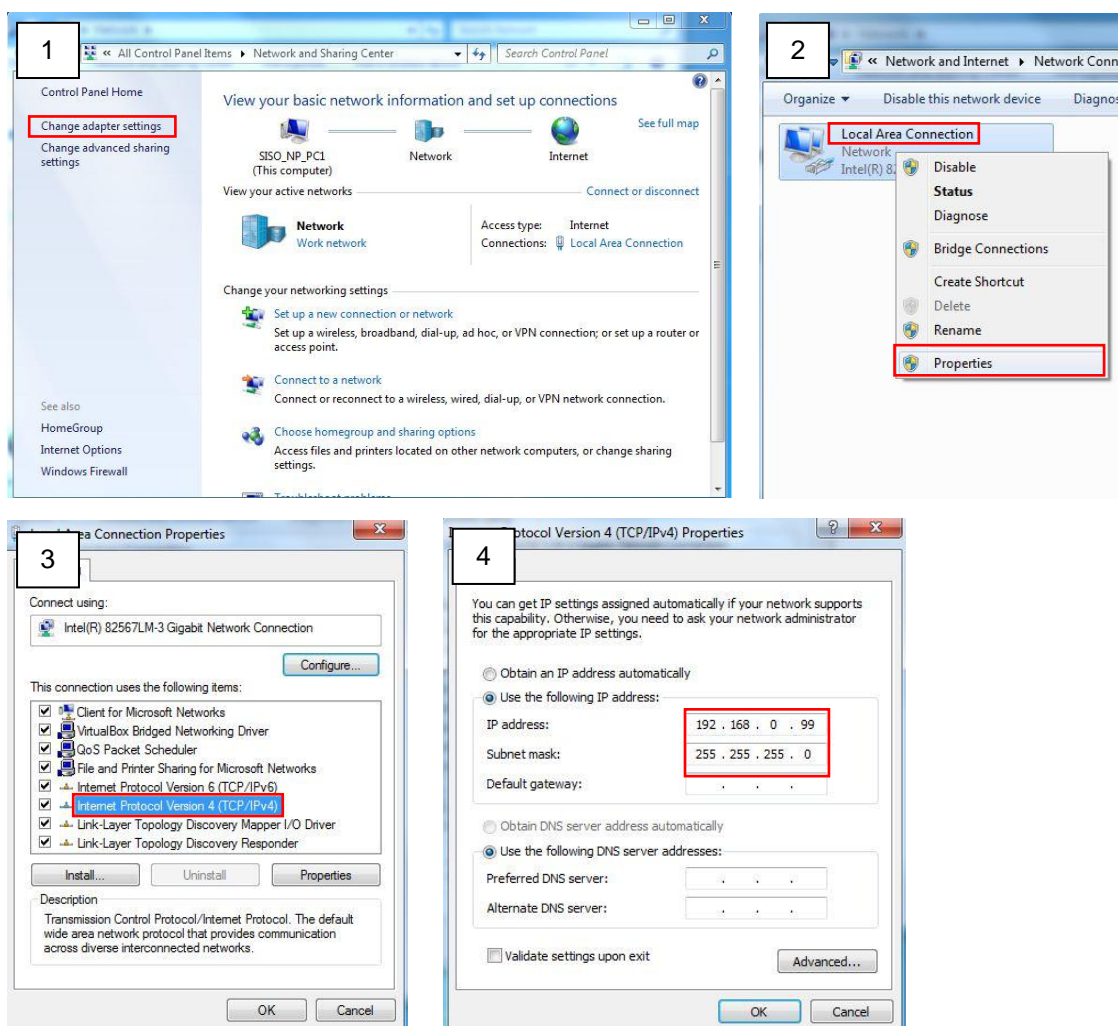

Manually adjust the IP addresses of multiple cameras:

If there are more than 1 camera to be used in the same local area network and there is no DHCP server to assign unique IP addresses to each of them, all of the cameras would then have the initial IP address of **192.168.0.100**, which is not a proper situation for network devices – all the IP addresses have to be different from each other. The easiest way to assign cameras the IP addresses is by using **IP Utility**:

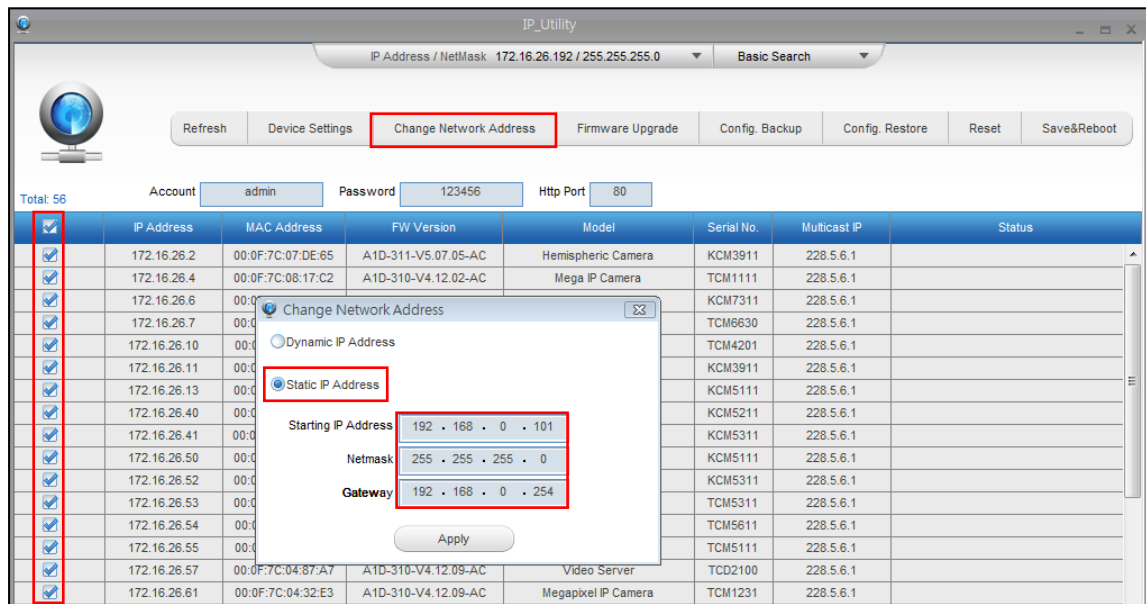

With the procedure shown above, all the cameras will have unique IP addresses, starting from 192.168.0.101. In case there are 20 cameras selected, the last one of the cameras would have the IP 192.168.0.120.

Later, by pressing the “Refresh” button of the IP Utility, you will be able to see the list of cameras with their new IP addresses.

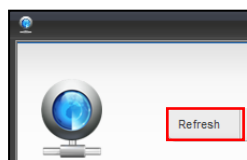

Please note that it is also possible to change the IP addresses manually by using the Web browser. In such case, please plug in only one camera at a time, and change its IP address by using the Web browser before plugging in the next one. This way, the Web browser will not be confused about two devices having the same IP address at the same time.

Access the Camera

Now that the camera and the PC are both having their unique IP addresses and are under the same network segment, it is possible to use the Web browser of the PC to access the camera.

You can use **any of the browsers** to access the camera, however, the full functionality is provided only for **Microsoft Internet Explorer**.

The browser functionality comparison:

Functionality	Internet Explorer	Other browsers
Live Video	Yes	Yes*
Live Video Area Resizable	Yes	No
PTZ Control	Yes	Yes
Capture the snapshot	Yes	Yes
Video overlay based configuration (Motion Detection regions, Privacy Mask regions)	Yes	No
All the other configurations	Yes	Yes

* When using non-Internet Explorer browsers, free third-party software plug-ins must be installed to the PC first to be able to get the live video feed from the camera:

Browser	Required Plug-In
Safari	QuickTime (http://www.apple.com/quicktime/download/)
Other non-Internet Explorer browsers	Basic VLC Media Player (http://www.videolan.org)

***Disclaimer Notice:** The camera manufacturer does not guarantee the compatibility of its cameras with VLC player or QuickTime – since these are third party softwares. The third party has the right to modify their utility any time which might affect the compatibility. In such cases, please use Internet Explorer browser instead.*

When using Internet Explorer browser, the ActiveX control for video stream management will be downloaded from the camera directly – the user just has to accept the use of such control when prompted so. No other third party utilities are required to be installed in such case.

The following examples in this manual are based on Internet Explorer browser in order to cover all functions of the camera.

Assuming that the camera's IP address is **192.168.0.100**, you can access it by opening the Web browser and typing the following address into Web browser's address bar:

http://192.168.0.100

Upon successful connection to the camera, the user interface called **Web Configurator** would appear together with the login page. The HTTP port number was not added behind the IP address since the default HTTP port of the camera is 80, which can be omitted from the address for convenience.

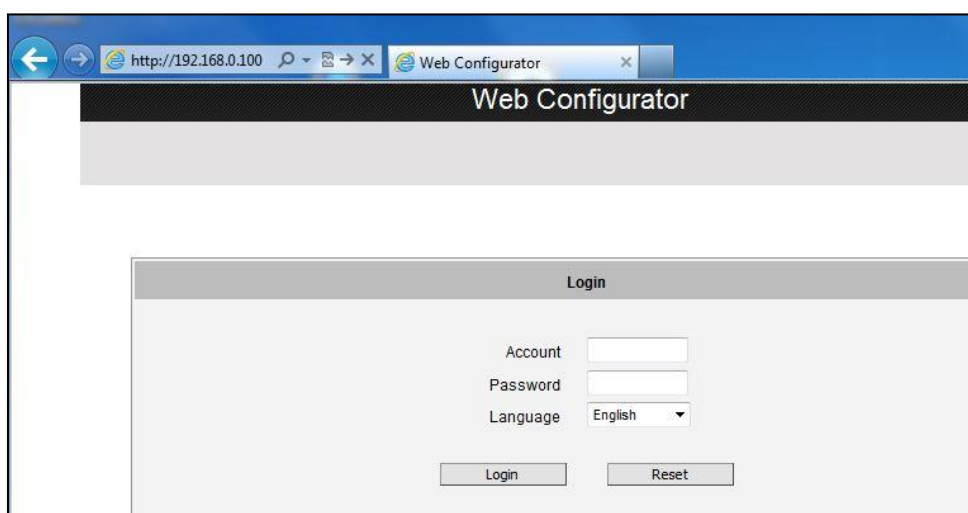

Before logging in, you need to know the factory default Account and Password of the camera.

Account: **Admin**

Password: **123456**



Copyright © 2014, ACTi Corporation All Rights Reserved

7F, No. 1, Alley 20, Lane 407, Sec. 2, Ti-Ding Blvd., Neihu District, Taipei, Taiwan 114, R.O.C.

TEL : +886-2-2656-2588 FAX : +886-2-2656-2599

Email: sales@acti.com