



Bullet Camera

Hardware Manual

D31, D32

Ver. 2013/12/24



ACTi
Connecting Vision

Table of Contents

Precautions **3**

Safety Instructions 5

Introduction **6**

List of Models..... 6

Package Contents..... 7

Physical Description 8

Installation Procedures **9**

Mount the Camera 9

 Using the Bundled Bracket..... 9

 Other Mounting Options 12

Basic Connections 13

 Connecting a Single Camera 13

 Connecting Multiple Cameras 14

Accessing the Camera **15**

Configure the IP Addresses 15

 Using DHCP Server to Assign IP Addresses..... 15

 Using the Default Camera IP Address..... 17

Access the Camera..... 19

Other Adjustments and Accessories **22**

Adjust Camera Focus..... 22

Attach the Sunshield 24

Reset the Camera 25

Precautions

Read these instructions

You should read all the safety and operating instructions before using this product.

Heed all warnings

You must adhere to all the warnings on the product and in the instruction manual. Failure to follow the safety instruction given may directly endanger people, cause damage to the system or to other equipment.

Servicing

Do not attempt to service this video device yourself as opening or removing covers may expose you to dangerous voltage or other hazards. Refer all servicing to qualified service personnel.

Trademarks

All names used in this manual are probably registered trademarks of respective companies.

Liability

Every reasonable care has been taken during the writing of this manual. Please inform your local office if you find any inaccuracies or omissions. We cannot be held responsible for any typographical or technical errors and reserve the right to make changes to the product and manuals without prior notice.

Federal Communications Commission Statement



This equipment has been tested and found to comply with the limits for a class B digital device, pursuant to Part 15 of the FCC Rules. These limits are designed to provide reasonable protection against harmful interference in a residential installation. This equipment generates, uses, and can radiate radio frequency energy and, if not installed and used in accordance with the instructions, may cause harmful interference to radio communications. However, there is no guarantee that interference will not occur in a particular installation. If this equipment does cause harmful interference to radio or television reception, which can be determined by turning the equipment off and on, the user is encouraged to try to correct the interference by one or more of the following measures:

- Reorient or relocate the receiving antenna.
- Increase the separation between the equipment and receiver.
- Connect the equipment into an outlet on a circuit different from that to which the receiver is connected.
- Consult the dealer or an experienced radio/TV technician for help.

Warning: Changes or modifications to the equipment that are not expressly approved by the responsible party for compliance could void the user's authority to operate the equipment.

European Community Compliance Statement



This product has been tested and found to comply with the limits for Class B Information Technology Equipment according to European Standard EN 55022 and EN 55024. In a domestic environment, this product may cause radio interference in which cause the user may be required to take adequate measures.

Safety Instructions

Cleaning

Disconnect this video product from the power supply before cleaning.

Attachments

Do not use attachments not recommended by the video product manufacturer as they may cause hazards.

Water and Moisture

Do not use this video product near water, for example, near a bathtub, washbowl, kitchen sink, or laundry tub, in a wet basement, or near a swimming pool and the like.

Don't use accessories not recommended by the manufacturer

Only install this device in a dry place protected from weather

Servicing

Do not attempt to service this video product yourself as opening or removing covers may expose you to dangerous voltage or other hazards. Refer all servicing to qualified service personnel.

Damage Requiring service

Disconnect this video product from the power supply immediately and refer servicing to qualified service personnel under the following conditions.

- 1) When the power-supply cord or plug is damaged
- 2) If liquid has been spilled, or objects have fallen into the video product.
- 3) If the video product has been directly exposed to rain or water.
- 4) If the video product does not operate normally by following the operating Instructions in this manual. Adjust only those controls that are covered by the instruction manual, as an improper adjustment of other controls may result in damage, and will often require extensive work by a qualified technician to restore the video product to its normal operation.



Safety Check

Upon completion of any service or repairs to this video product, ask the service technician to perform safety checks to determine if the video product is in proper operating condition.

Introduction

List of Models

This hardware manual contains the following models:

D31		1MP Bullet with D/N, IR, Fixed lens
D32		3MP Bullet with D/N, IR, Fixed lens

Package Contents

Bullet Camera



Sunshield



Lens Focus Tuner



Mounting Screw Kit



Sunshield Screw Kit



Quick Installation Guide

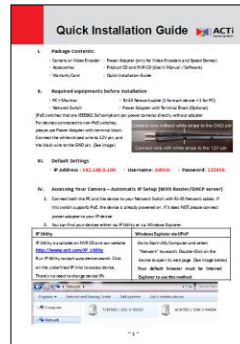

Bracket



Bracket Plate



Warranty Card

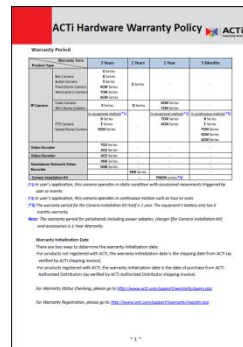

Physical Description

Main View



Back Interior View

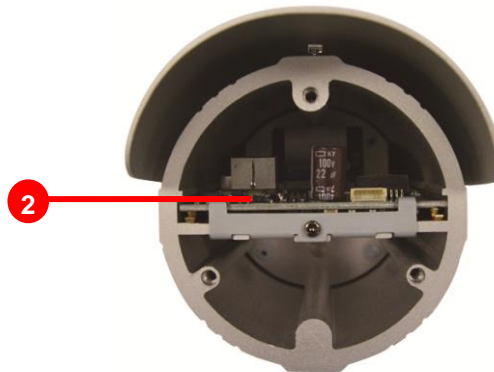

1) Ethernet Port

Connects to the network and power source. See [Basic Connections](#) on page 13 for more instructions.

2) Reset Button

Press and hold the Reset button for 5 seconds to reset the camera to its default factory settings. See [Reset the Camera](#) on page 25 for more instructions.

Installation Procedures

Mount the Camera

Using the Bundled Bracket

1. Mark the location of the three (3) screw holes using the bracket plate included in the package.

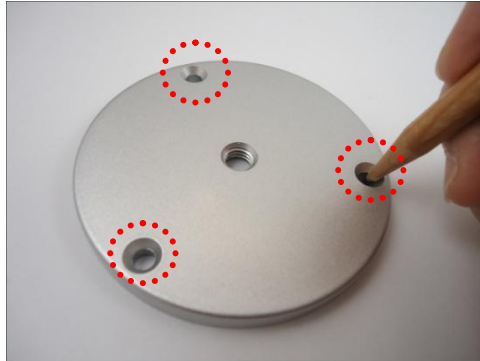

NOTE: Depending on the surface where you will install the camera, it may be necessary to drill the holes and use the supplied screw tox.

2. Attach the plate to the surface using the three (3) supplied screws.

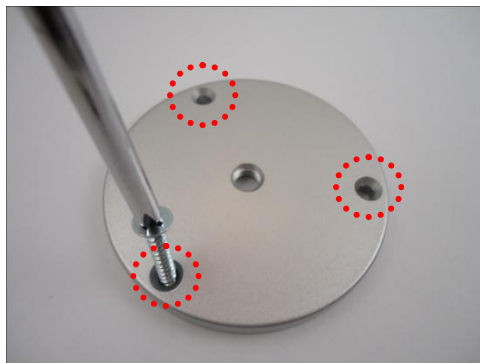

3. Attach the bracket to the plate.



- Depending on how you want to install the camera, attach the camera to the bracket through one of the three (3) holes below:



If the camera will be installed indoors and the use of sunshield is not necessary, you may also use one of the two (2) holes on top of the camera to mount the bracket to the ceiling. First, remove the pre-installed screw nut using a wrench (not included in the package). Below is an example of this type of installation.



- Adjust the camera viewing angle and tighten the knob to fix the camera position.

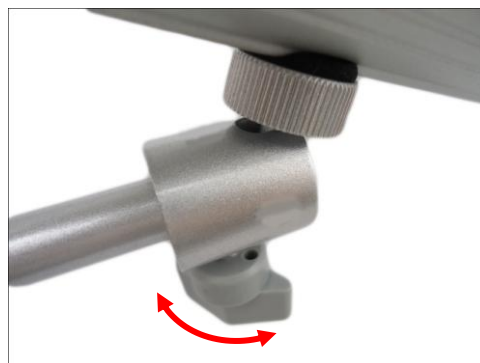

6. Connect an Ethernet cable from the network side to the Ethernet port of the camera to complete the installation. See [Basic Connections](#) on page 13 for more information.

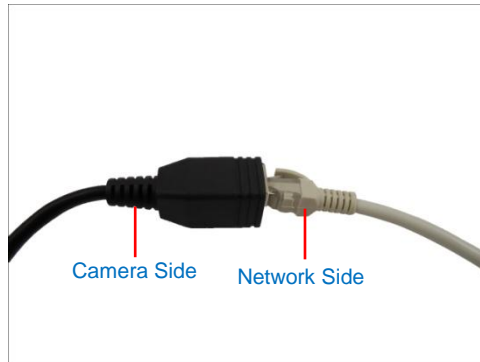

NOTES on using Ethernet cables: For outdoor installations, it is recommended to use *exterior-grade* Ethernet cables (CAT5/CAT5e/CAT6); ordinary Ethernet cables are only designed for indoor use and may deteriorate quickly when exposed to outdoor elements. Exterior-grade Ethernet cables are waterproof and do not require a conduit.





 **CAUTION:** If the camera will be installed outdoors, be sure to waterproof the cable connection by enclosing it inside a junction box or wrap it using a moisture-sealant tape, such as **3M PRODUCTS Core Series 4-1000** (not included in the package) or equivalent. See example below.



Other Mounting Options

In areas with fierce weather conditions, the light bundled bracket can be replaced by a heavy duty outdoor bracket combined with additional mounting accessories.

Below are the optional mounting accessories that you can use with the camera.

Mount Types	Accessories		
Corner Mount	Suitable when mounting the camera on a corner wall.		
	PMAX-1103 	+	PMAX-0402 
Pole Mount	Suitable when mounting the camera on a pole.		
	PMAX-1103 	+	PMAX-0503 

NOTE:

- For more information about the mounting solutions and accessories, please check the [Mounting Accessory Selector](http://www.acti.com/mountingselector) in our website (<http://www.acti.com/mountingselector>).
- The above mounting accessories are not included in the package. Contact your sales agents to purchase.

Basic Connections

To connect the camera, you need to prepare the following:

- Power over Ethernet (PoE) supported switch (to connect multiple cameras) or PoE injector (to connect a single camera)
- Ethernet cables

Connecting a Single Camera

To connect a single camera, use a PoE injector to supply both data and power to the camera using one Ethernet cable. Follow the procedures below:

1. Connect the camera to the PoE injector using an Ethernet cable.
2. Connect the PoE injector to the network and an AC power source.
3. Connect a PC to the same network.

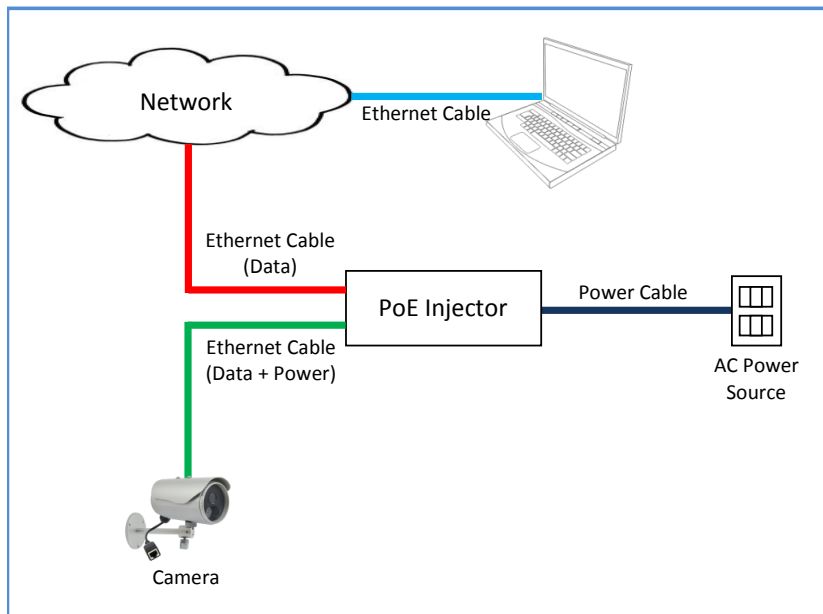

4. After making the connections, access the camera live view to adjust the focus and configure the camera settings according to your preference. See [Accessing the Camera](#) on page 15 for more information.

Connecting Multiple Cameras

To connect multiple cameras, use a PoE switch.

1. Connect the camera(s) to the PoE switch using Ethernet cables.
2. Connect the PoE switch to a network and an AC power source.
3. Connect a PC to the same network.

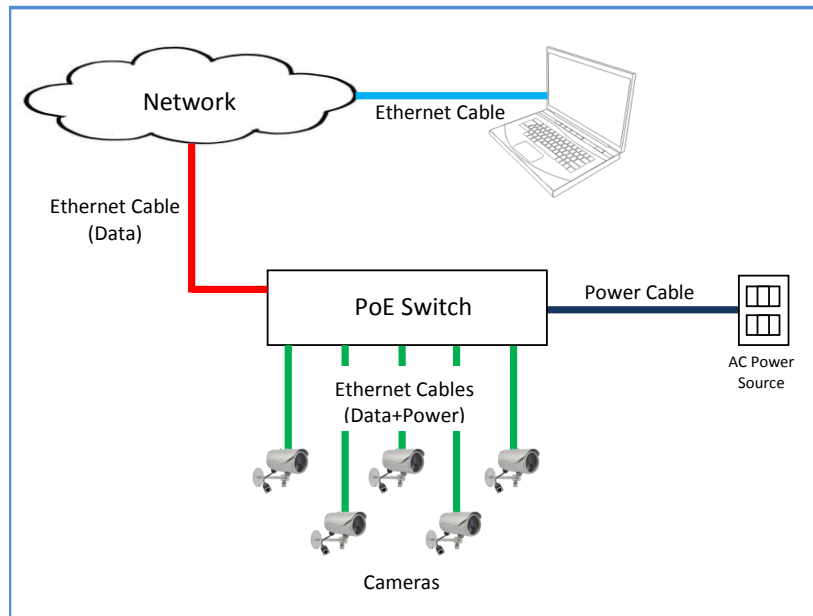

4. After making the connections, access the cameras live view to adjust the focus and configure the camera settings according to your preference. See [Accessing the Camera](#) on page 15 for more information.

Accessing the Camera

Configure the IP Addresses

In order to be able to communicate with the camera from your PC, both the camera and the PC have to be within the same network segment. In most cases, it means that they both should have very similar IP addresses, where only the last number of the IP address is different from each other. There are 2 different approaches to IP Address management in Local Area Networks – by DHCP Server or Manually.

Using DHCP Server to Assign IP Addresses

If you have connected the computer and the camera into the network that has a DHCP server running, then you do not need to configure the IP addresses at all – both the camera and the PC would request a unique IP address from DHCP server automatically. In such case, the camera will immediately be ready for the access from the PC. The user, however, might not know the IP address of the camera yet. It is necessary to know the IP address of the camera in order to be able to access it by using a Web browser.

The quickest way to discover the cameras in the network is to use the simplest network search, built in the Windows system – just by pressing the “Network” icon, all the cameras of the local area network will be discovered by Windows thanks to the UPnP function support of our cameras.

In the example below, we successfully found the camera that we had just connected to the network.

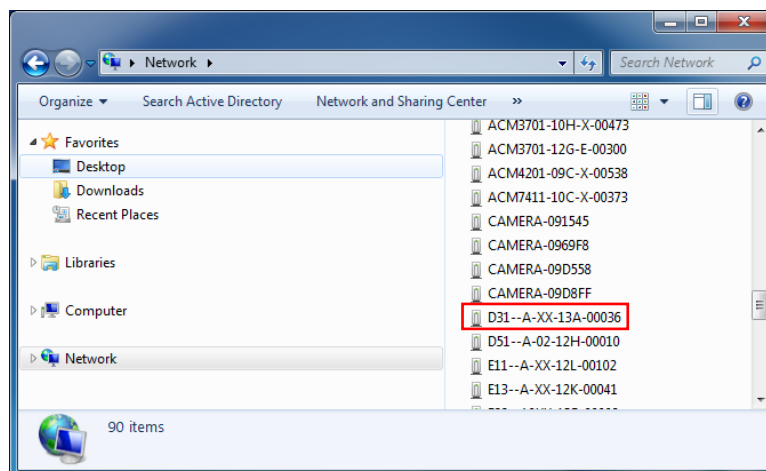

By double-clicking with the left mouse on the camera model, it is possible to automatically launch the default browser of the PC with the IP address of the target camera filled in the address bar of the browser already.

If you work with our cameras regularly, then **there is even a better way to discover the cameras in the network** – by using **IP Utility**. The IP Utility is a light software tool that can not only discover the cameras, but also list lots of valuable information, such as IP and MAC addresses, serial numbers, firmware versions, etc, and allows quick configuration of multiple devices at the same time.

The IP Utility can be downloaded for free from http://www.acti.com/IP_Utility

With just one click, you can launch the IP Utility and there will be an instant report as follows:

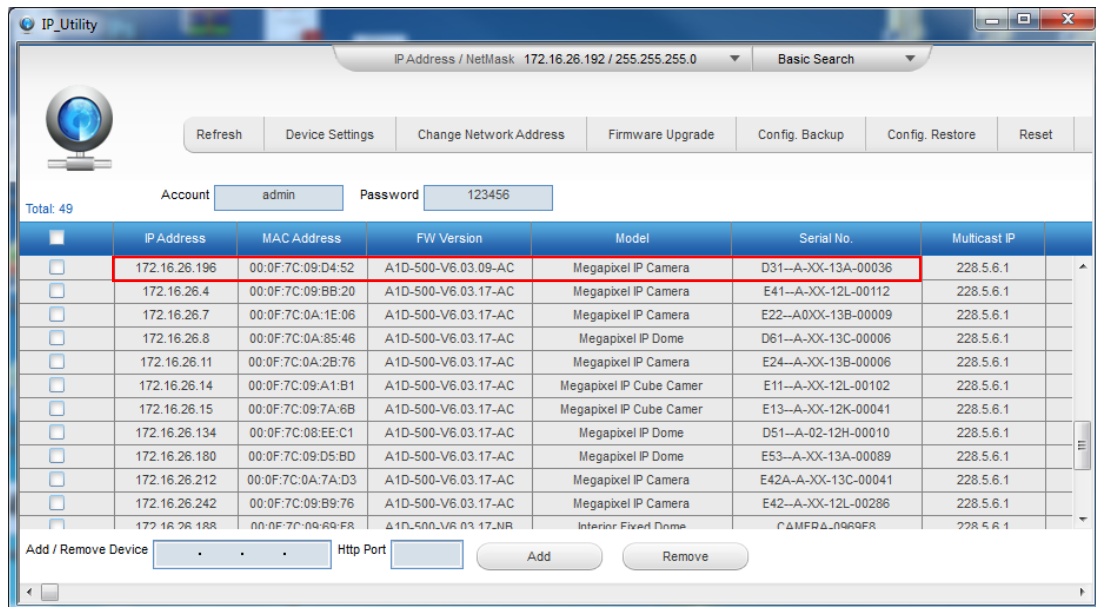

You can quickly see the camera model in the list. Click on the IP address to automatically launch the default browser of the PC with the IP address of the target camera filled in the address bar of the browser already.

Using the Default Camera IP Address

If there is no DHCP server in the given network, the user may have to assign the IP addresses to both PC and camera manually to make sure they are in the same network segment.

When the camera is plugged into network and it does not detect any DHCP services, it will automatically assign itself a default IP:

192.168.0.100

Whereas the default port number would be **80**. In order to access that camera, the IP address of the PC has to be configured to match the network segment of the camera.

Manually adjust the IP address of the PC:

In the following example, based on Windows 7, we will configure the IP address to **192.168.0.99** and set Subnet Mask to **255.255.255.0** by using the steps below:

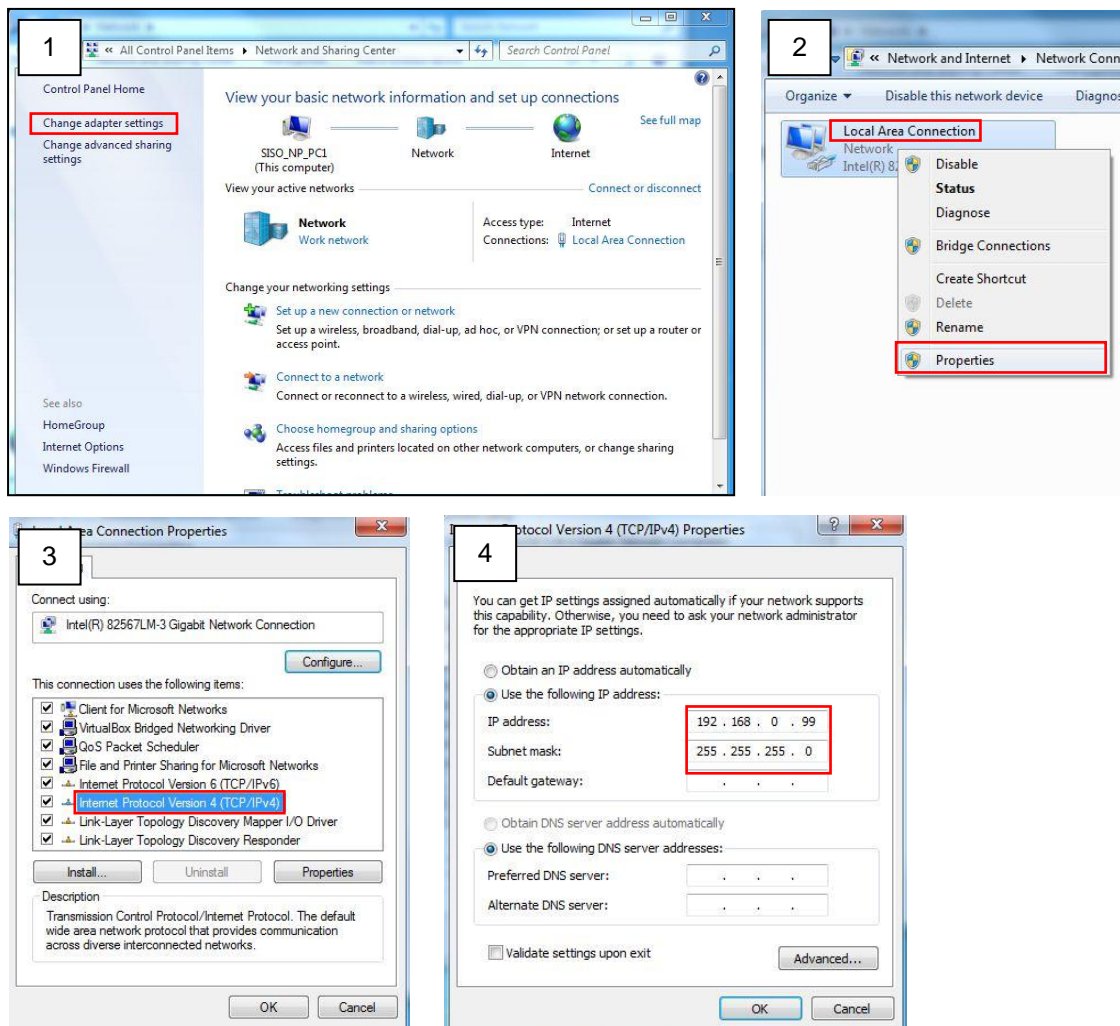

Manually adjust the IP addresses of multiple cameras:

If there are more than 1 camera to be used in the same local area network and there is no DHCP server to assign unique IP addresses to each of them, all of the cameras would then have the initial IP address of **192.168.0.100**, which is not a proper situation for network devices – all the IP addresses have to be different from each other. The easiest way to assign cameras the IP addresses is by using **IP Utility**:

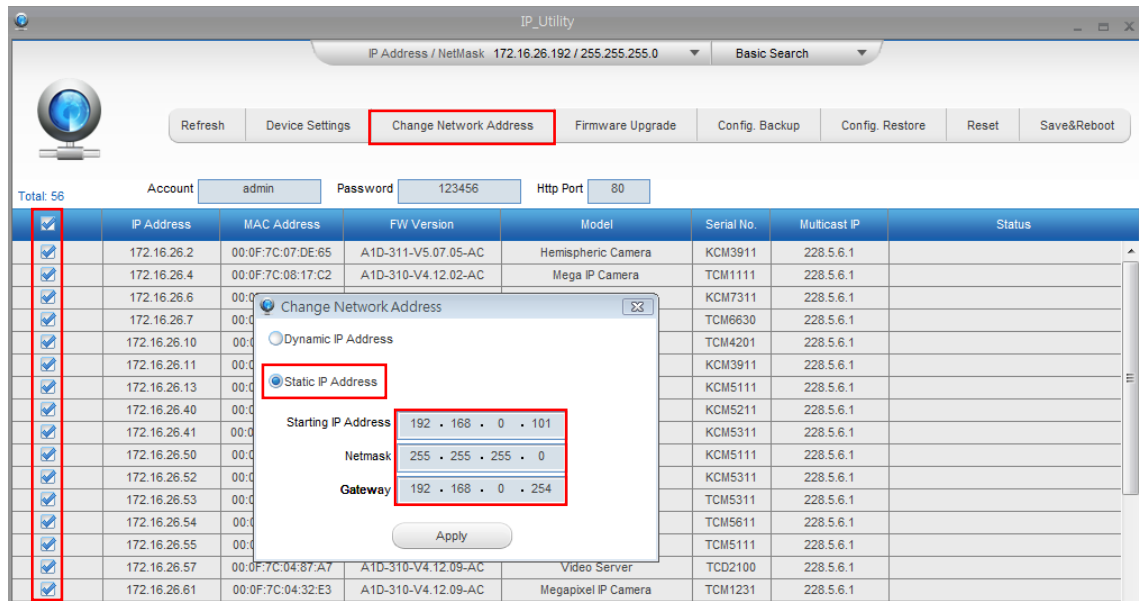

With the procedure shown above, all the cameras will have unique IP addresses, starting from 192.168.0.101. In case there are 20 cameras selected, the last one of the cameras would have the IP 192.168.0.120.

Later, by pressing the “Refresh” button of the IP Utility, you will be able to see the list of cameras with their new IP addresses.



Please note that it is also possible to change the IP addresses manually by using the Web browser. In such case, please plug in only one camera at a time, and change its IP address by using the Web browser before plugging in the next one. This way, the Web browser will not be confused about two devices having the same IP address at the same time.

Access the Camera

Now that the camera and the PC are both having their unique IP addresses and are under the same network segment, it is possible to use the Web browser of the PC to access the camera.

You can use **any of the browsers** to access the camera, however, the full functionality is provided only for **Microsoft Internet Explorer**.

The browser functionality comparison:

Functionality	Internet Explorer	Other browsers
Live Video	Yes	Yes*
Live Video Area Resizable	Yes	No
PTZ Control	Yes	Yes
Capture the snapshot	Yes	Yes
Video overlay based configuration (Motion Detection regions, Privacy Mask regions)	Yes	No
All the other configurations	Yes	Yes

* When using non-Internet Explorer browsers, free third-party software plug-ins must be installed to the PC first to be able to get the live video feed from the camera. Check the firmware version of the camera to determine which plug-in is necessary:

Firmware Version	Required Plug-In
A1D-500-V6.04.xx-AC or older	Basic VLC Media Player (http://www.videolan.org)
A1D-500-V6.05.xx-AC or newer	QuickTime (http://www.apple.com/quicktime/download/)

The camera firmware version can be found on the **FW Version** column of the IP utility or access the **Setup** page of the Web Configurator (see page 21).

***Disclaimer Notice:** The camera manufacturer does not guarantee the compatibility of its cameras with VLC player or QuickTime – since these are third party softwares. The third parties have the right to modify their utility any time which might affect the compatibility. In such cases, please use Internet Explorer browser instead.*

When using Internet Explorer browser, the ActiveX control for video stream management will be downloaded from the camera directly – the user just has to accept the use of such control when prompted so. No other third party utilities are required to be installed in such case.

The following examples in this manual are based on Internet Explorer browser in order to cover all functions of the camera.

Assuming that the camera's IP address is **192.168.0.100**, you can access it by opening the Web browser and typing the following address into Web browser's address bar:

http://192.168.0.100

Upon successful connection to the camera, the user interface called **Web Configurator** would appear together with the login page. The HTTP port number was not added behind the IP address since the default HTTP port of the camera is 80, which can be omitted from the address for convenience.

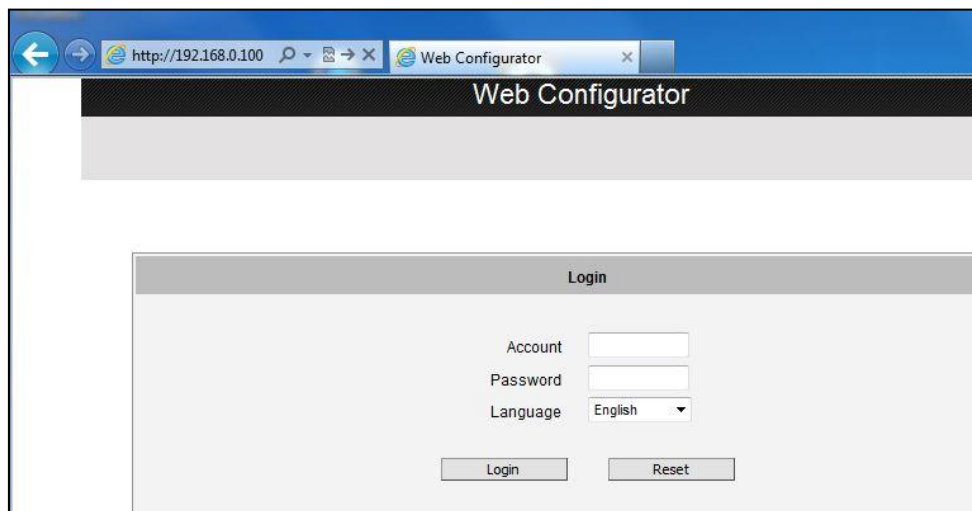

Before logging in, you need to know the factory default Account and Password of the camera.

Account: **Admin**

Password: **123456**

To check the firmware version through the Web Configurator, access the **Setup** page and click **System > System Info**.

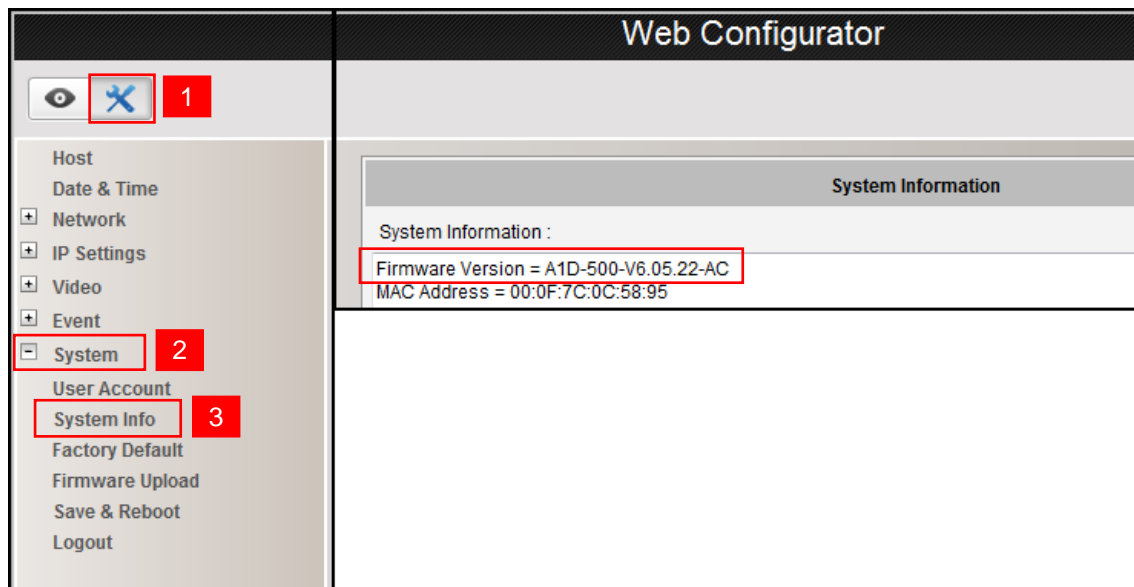

For further operations, please refer to the **Firmware User Manual**.

Other Adjustments and Accessories



Adjust Camera Focus

1. Remove the front cover ring.



2. Remove the front cover.

The camera models in this manual have three (3) designs. Check your camera design to know the suitable step in removing the front cover.

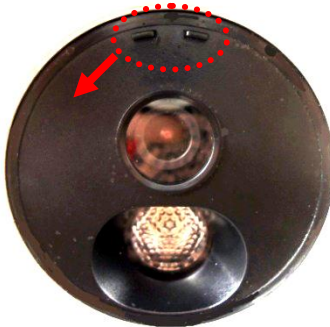
Design #1 Plain Front Cover	Design #2 Front Cover with Sticker	Design #3 Front Cover with Tabs
		
<p>Detach the front cover using an adhesive tape or a suction cup (not included in the package).</p>	<p>Pull the plastic tab to detach the front cover.</p>	<p>Use pliers to pull and detach the front cover.</p>

NOTE: For cameras with Design #2, remove the whole sticker from the front cover after adjusting the focus. The sticker cannot be reattached to the front cover. If the focus needs to be adjusted in the future, use a suction cup or adhesive tape to detach the front cover.

3. Attach the lens focus tuner to the lens.

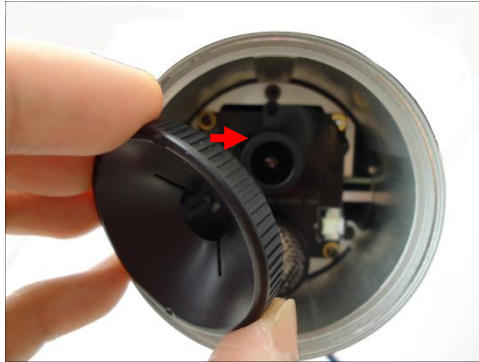

4. Adjust the focus based on the live view of the camera (see [Accessing the Camera](#) on page 15 to view the camera).



5. When done, attach the front cover and the front cover ring.

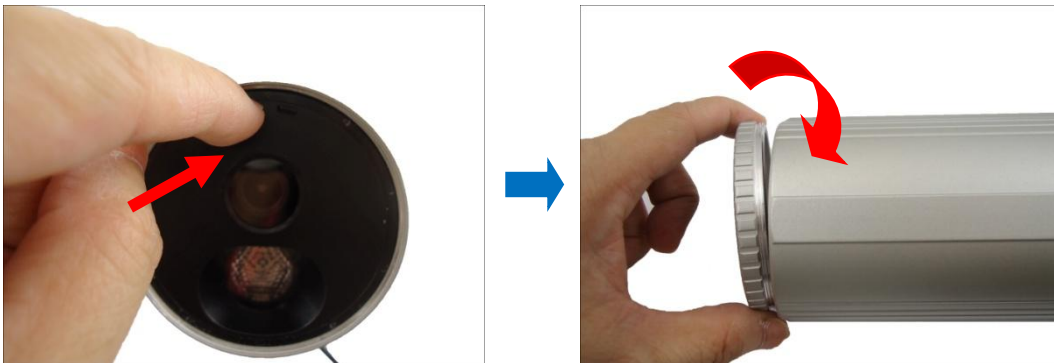

CAUTION: The front cover and front cover ring must be tightly closed to ensure water or dust does not go through any opening.

Attach the Sunshield

The use of sunshield is optional if the camera will be installed indoors. However, if the camera will be installed outdoors, attach the sunshield to protect the lens from all types of weather and lighting conditions.

1. Loosely secure the supplied screws and washers to attach the sunshield.



2. Slide to adjust the sunshield to cover the lens as far as possible but out of the camera's live view.



3. Tighten the screws to fix the position of the sunshield.

Reset the Camera

In case there is a need to reset the camera to its default factory settings, do the following procedures while the camera is powered on.

1. Loosen the three (3) screws securing the back cover.

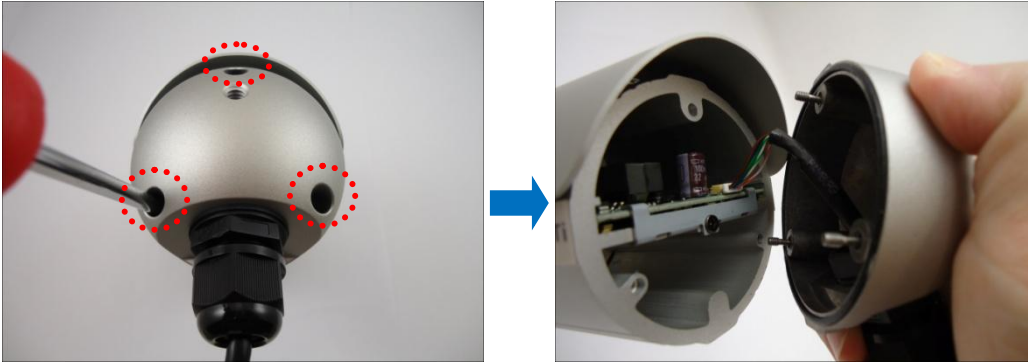

NOTE: A cable is connected inside the camera, do not abruptly pull the back cover.

2. Press and hold the Reset button for 5 seconds to reset the camera.

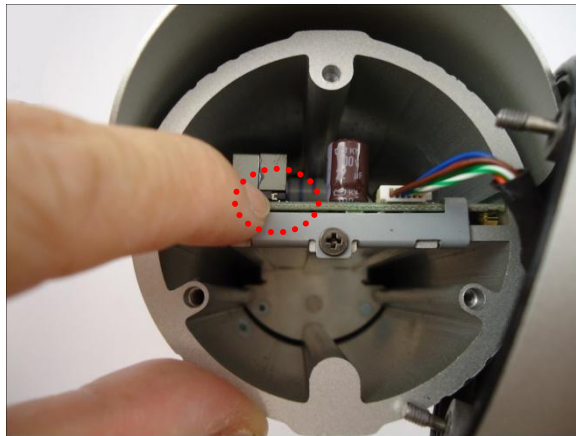

3. When done, ensure the rubber seal is aligned and attached to the back cover and then close the back cover by tightening the three (3) screws.

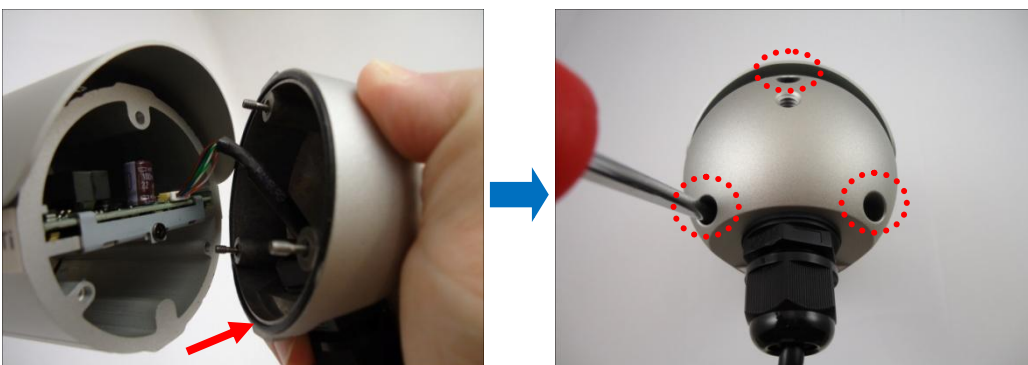

CAUTION: Make sure the rubber seal is properly attached and the back cover is closed to ensure water or dust cannot enter the camera.